

LEGO Secrets

Das kennt jeder!

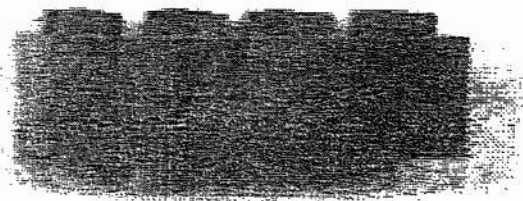

Verbindungsteile

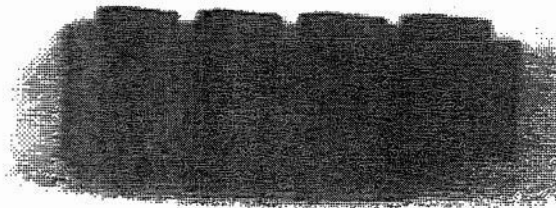
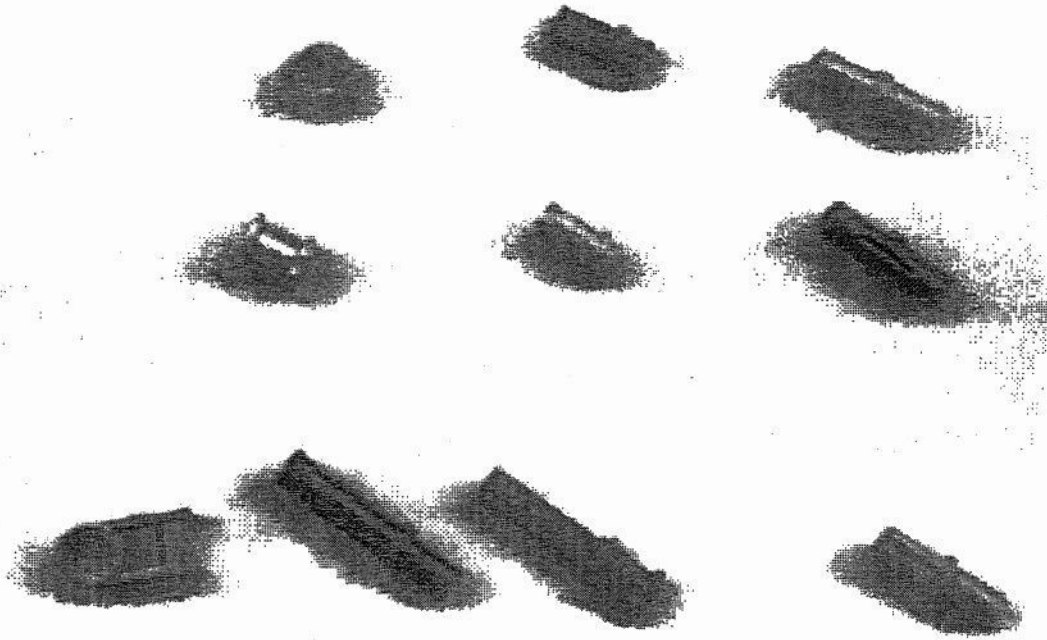

Größenverhältnisse 1

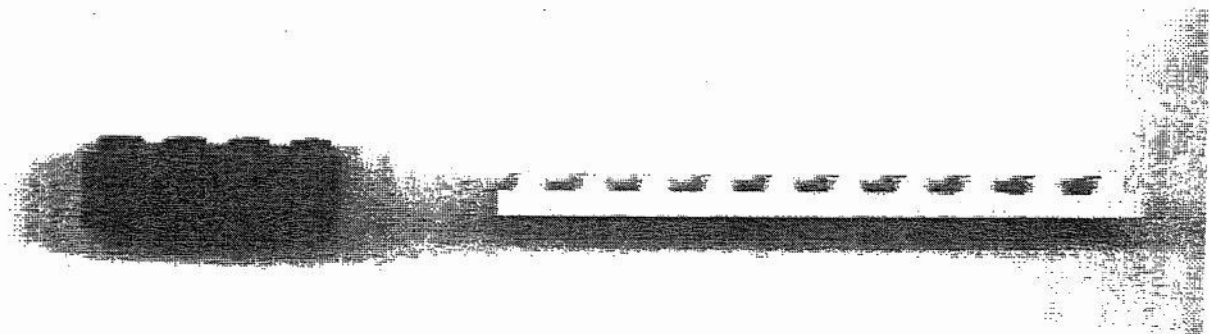

Größenverhältnisse 2

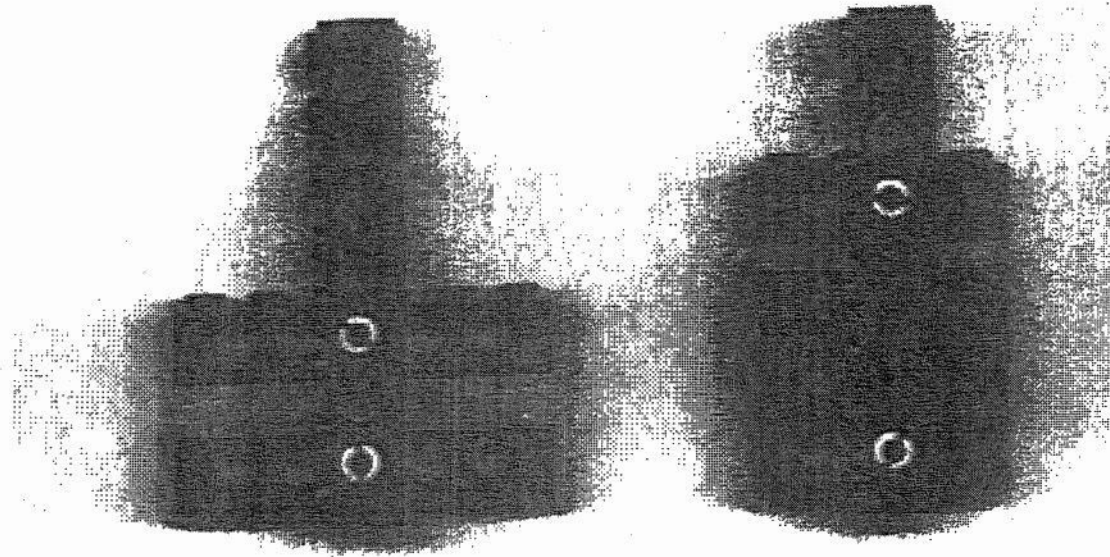

Größenverhältnisse 2

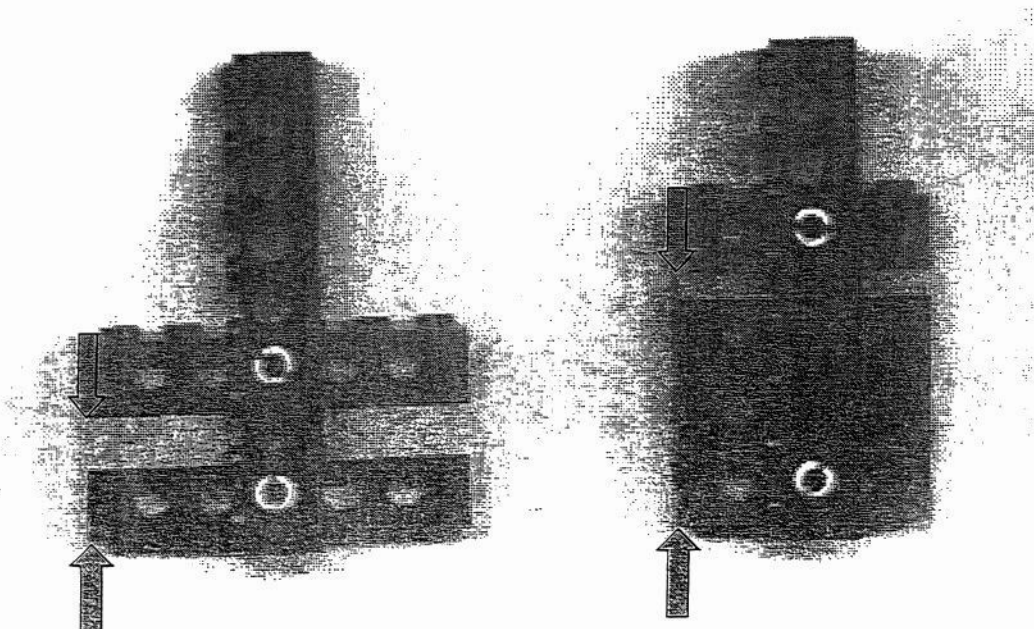

Größenverhältnisse 2

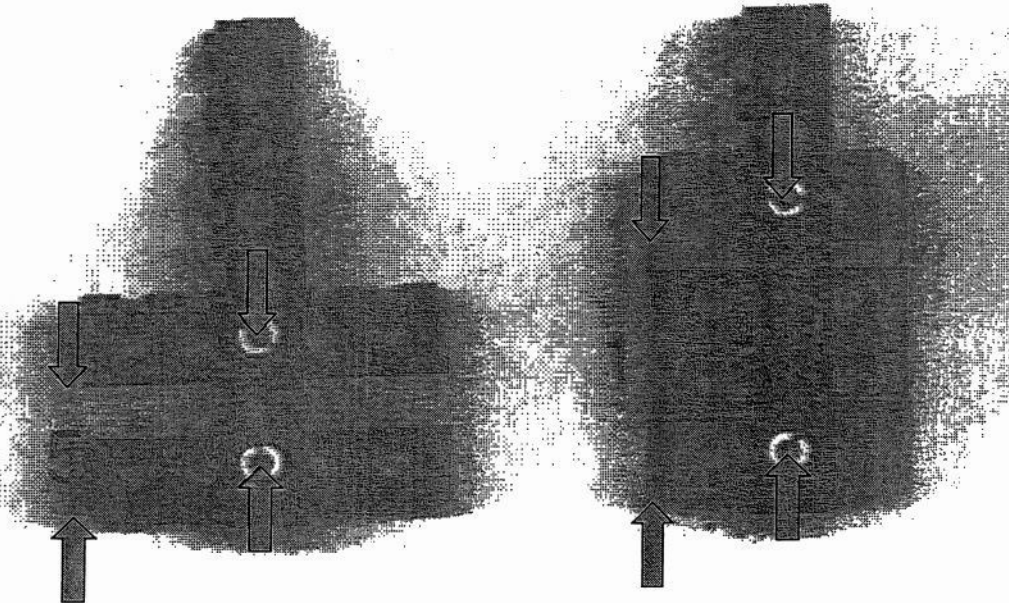

Größenverhältnisse 2

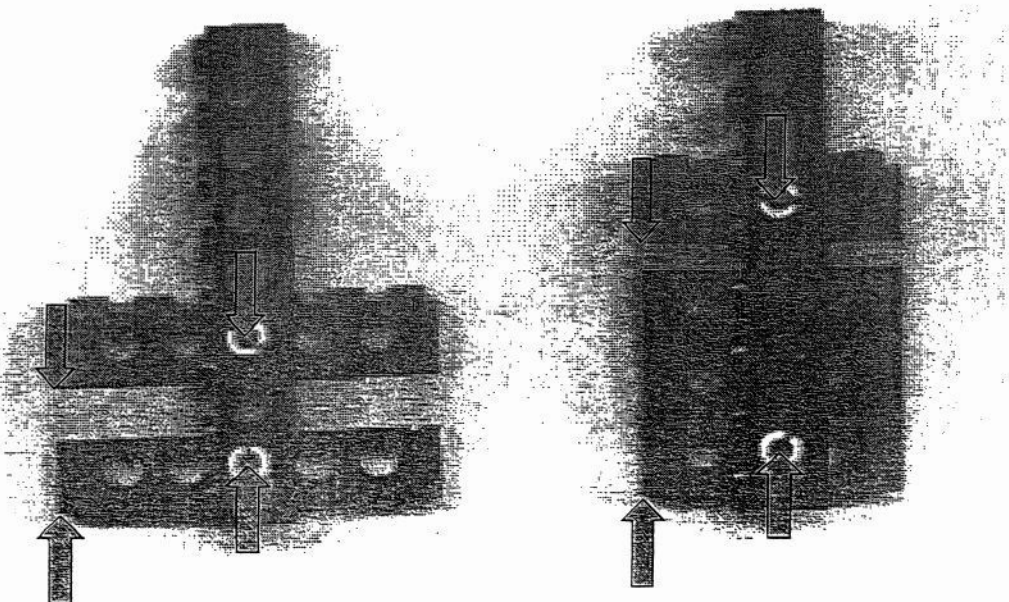

Ein rechter Winkel

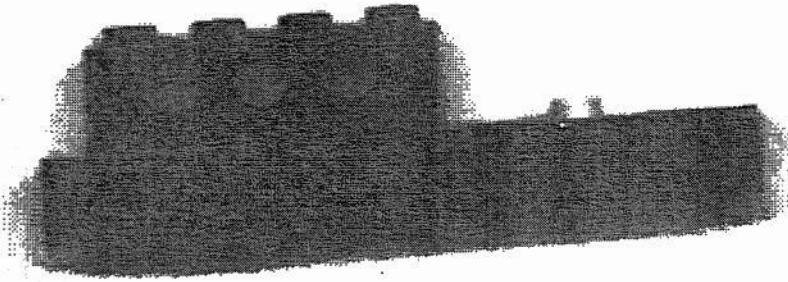

Noch ein rechter Winkel

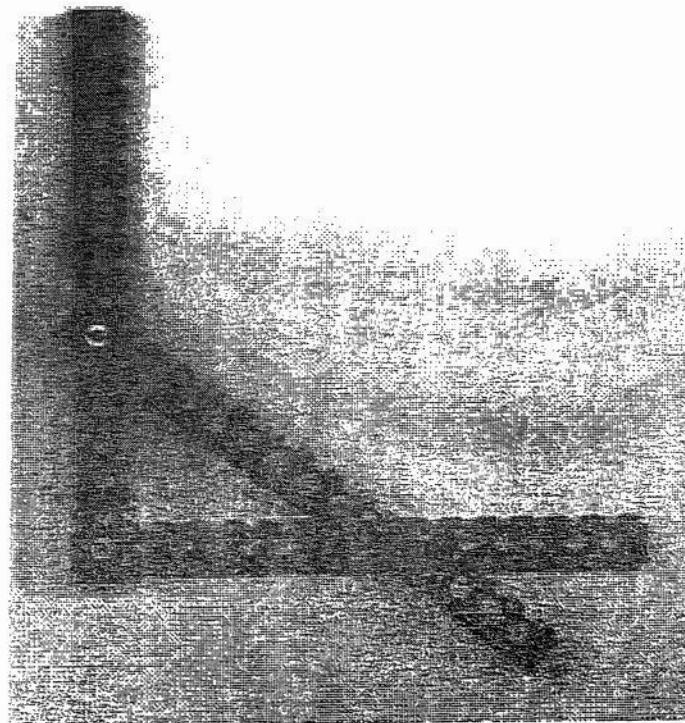

Zahnräder im Einsatz

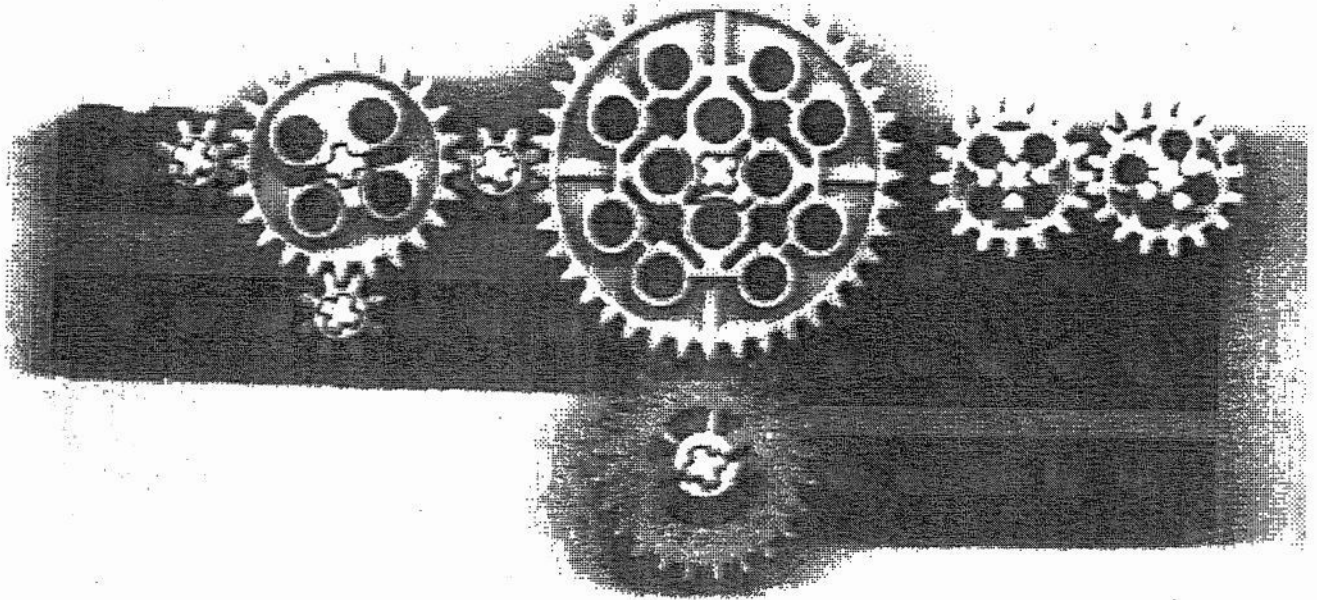

Zahnräder im Einsatz

$Z = 40$

$Z = 24$

$Z = 16$

$Z = 8$

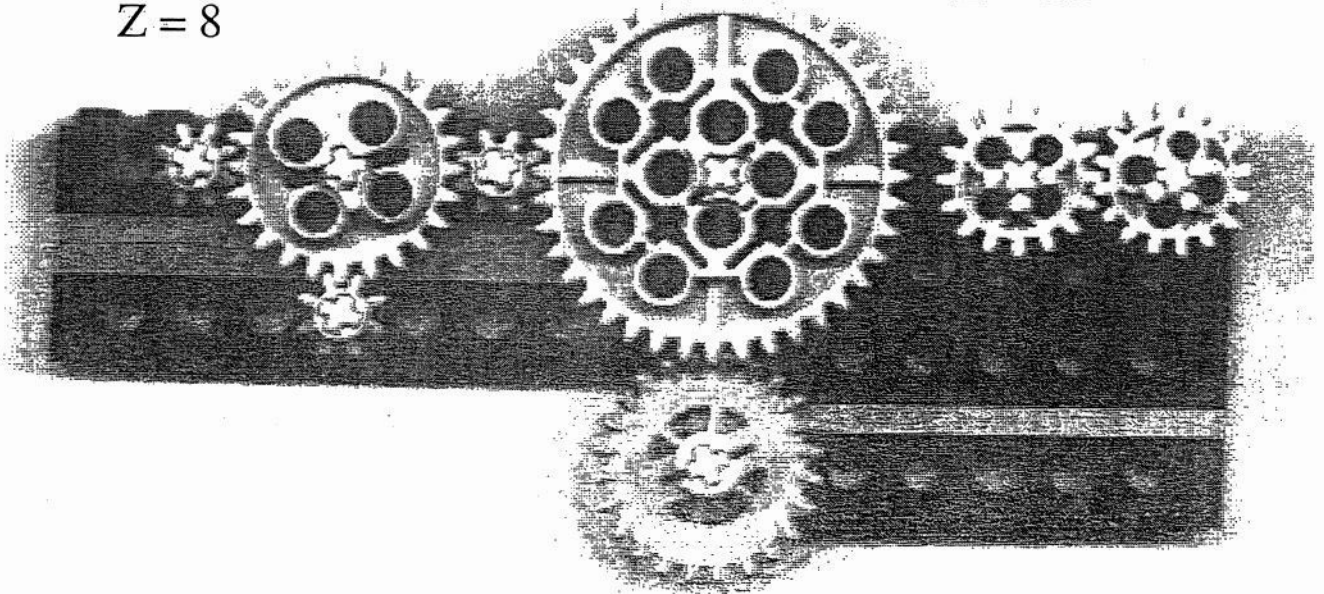

Zahnräder im Einsatz

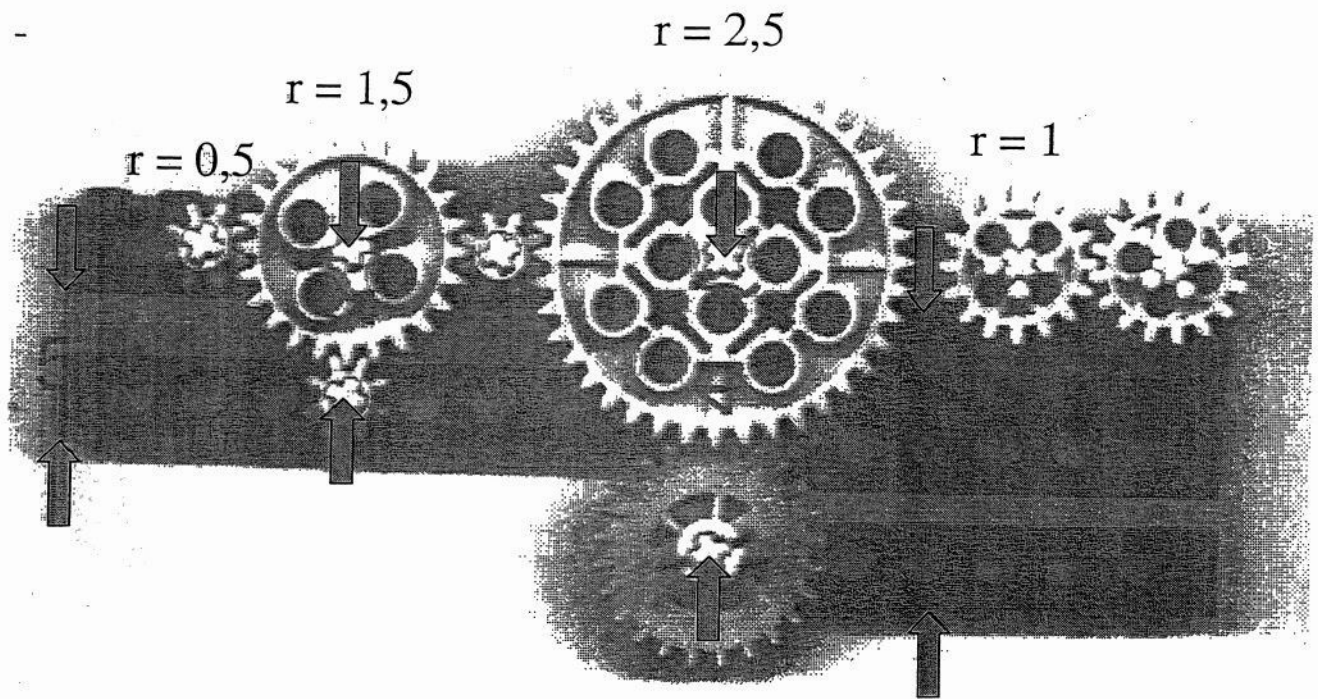

Zahnräder im Einsatz

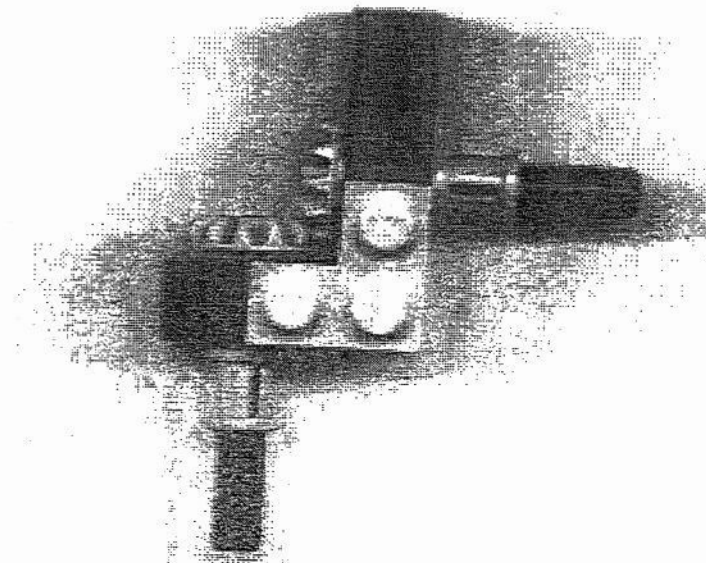

Differentialgetriebe

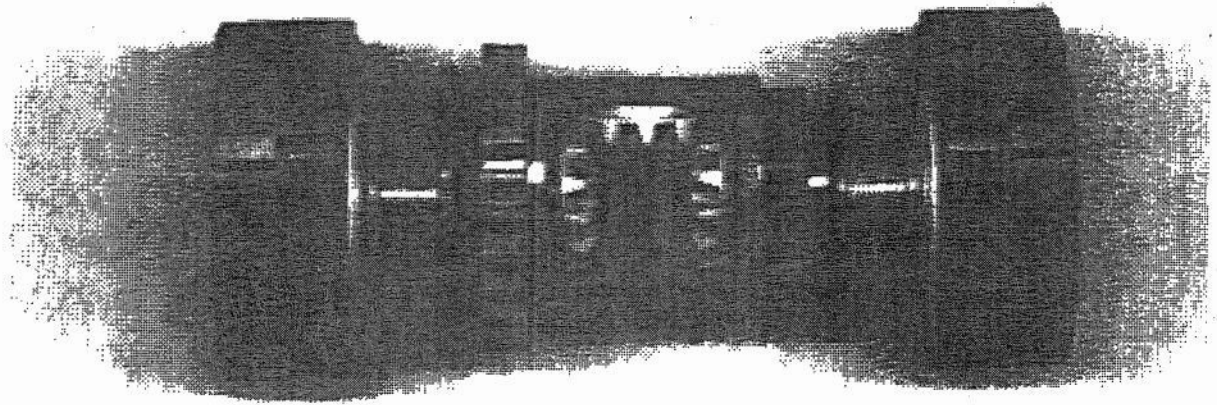

Ein Antrieb, zwei Funktionen

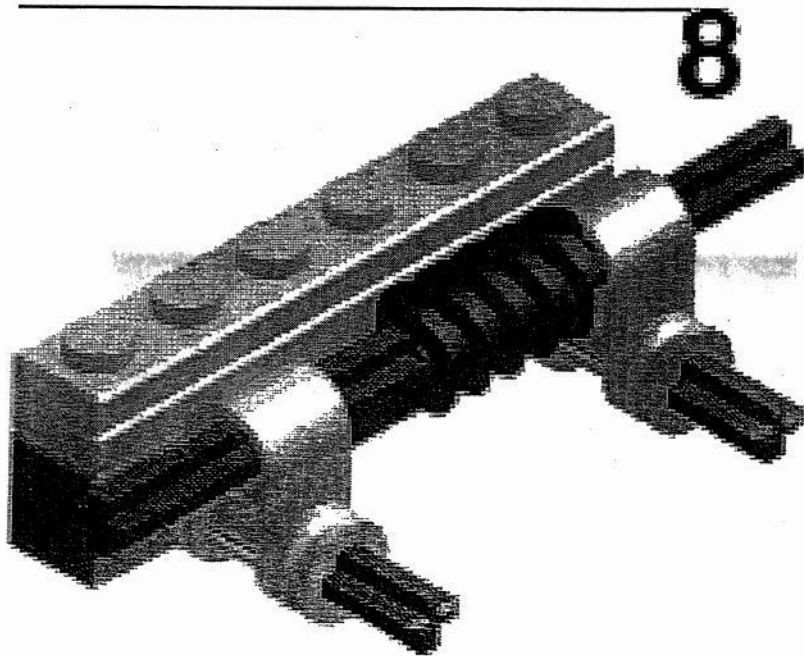

Ein Antrieb, zwei Funktionen

