

# $\omega$ -Automata

# $\omega$ -Automata

- Automata that accept (or reject) words of **infinite length**.
- Languages of infinite words appear:
  - in **verification**, as encodings of **non-terminating executions** of a program.
  - in **arithmetic**, as encodings of sets of **real numbers**.

# $\omega$ -Languages

- An  $\omega$ -word is an infinite sequence of letters.
- The set of all  $\omega$ -words is denoted by  $\Sigma^\omega$ .
- An  $\omega$ -language is a set of  $\omega$ -words, i.e., a subset of  $\Sigma^\omega$ .
- A language  $L_1$  can be concatenated with an  $\omega$ -language  $L_2$  to yield the  $\omega$ -language  $L_1L_2$ , but two  $\omega$ -languages cannot be concatenated.
- The  $\omega$ -iteration of a language  $L \subseteq \Sigma^*$ , denoted by  $L^\omega$ , is an  $\omega$ -language.
- Observe:  $\emptyset^\omega = \{\epsilon\}^\omega = \emptyset$

# $\omega$ -Regular Expressions

- $\omega$ -regular expressions have syntax

$$s ::= r^\omega \mid rs_1 \mid s_1 + s_2$$

where  $r$  is an (ordinary) regular expression.

- The  $\omega$ -language  $L_\omega(s)$  of an  $\omega$ -regular expression  $s$  is inductively defined by

$$L_\omega(r^\omega) = (L(r))^\omega \quad L_\omega(rs_1) = L(r)L_\omega(s_1)$$

$$L_\omega(s_1 + s_2) = L_\omega(s_1) \cup L_\omega(s_2)$$

- A language is  $\omega$ -regular if it is the language of some  $\omega$ -regular expression .

# Büchi Automata

- Invented by J.R. Büchi, swiss logician.

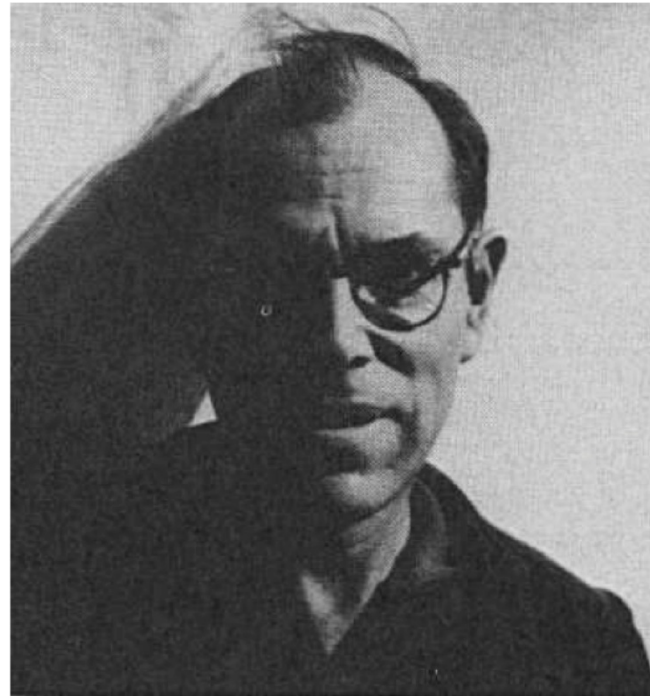

# Büchi Automata

- Same syntax as DFAs and NFAs, but different acceptance condition.
- A **run** of a Büchi automaton on an  $\omega$ -word is an infinite sequence of states and transitions.
- A run is **accepting** if it **visits** the set of final states **infinitely often**.
  - Final states renamed to **accepting states**.
- A DBA or NBA **accepts an  $\omega$ -word** if it has an accepting run on it; the  $\omega$ -language  $L_\omega(A)$  of  $A$  is the set of  $\omega$ -words it accepts.

# Some examples

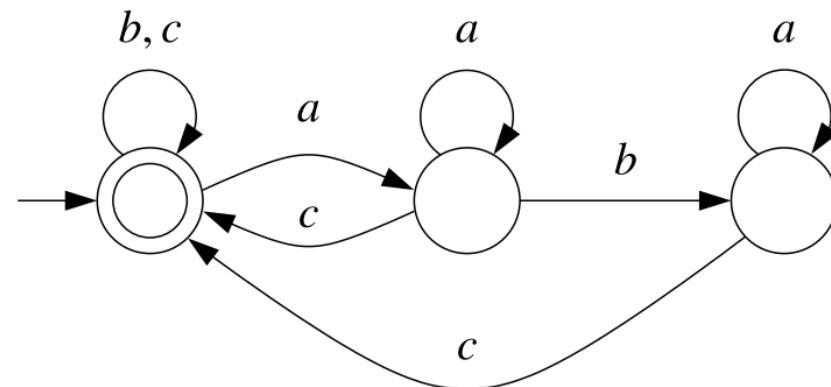
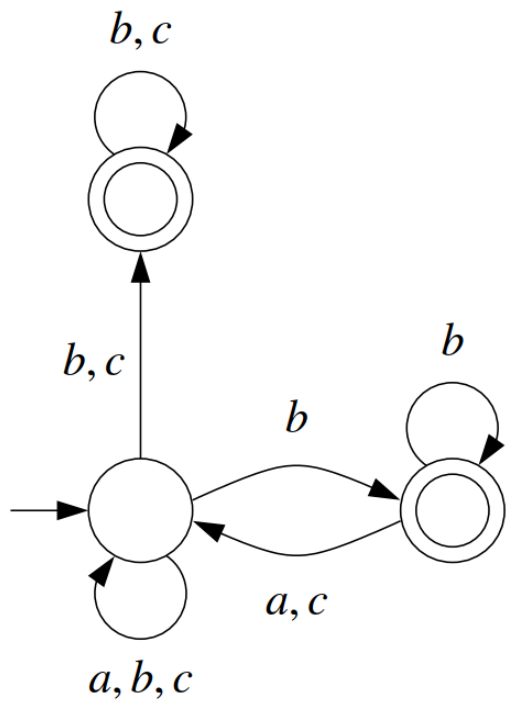
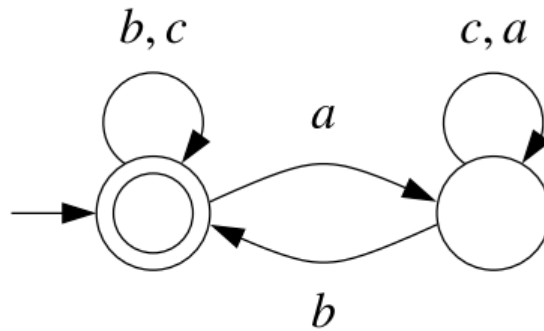
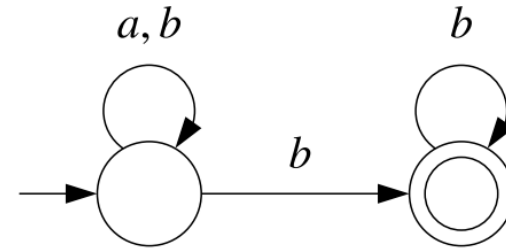
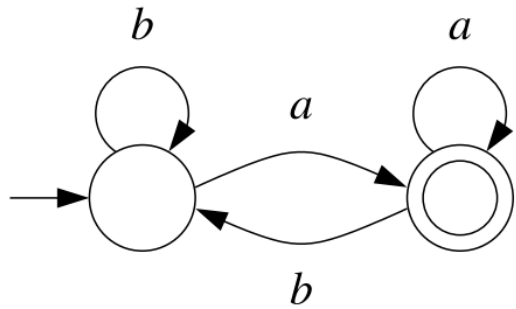

# From $\omega$ -Regular Expressions to NBAs

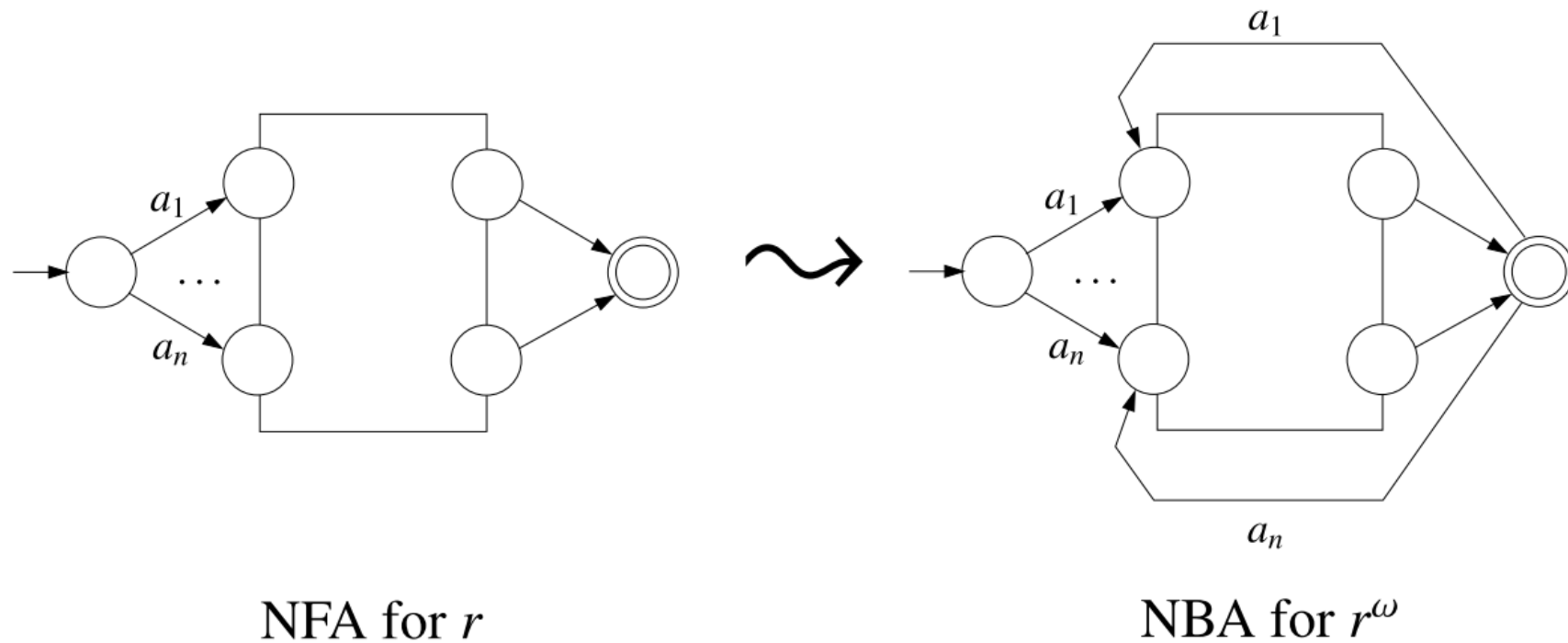



# From $\omega$ -Regular Expressions to NBAs

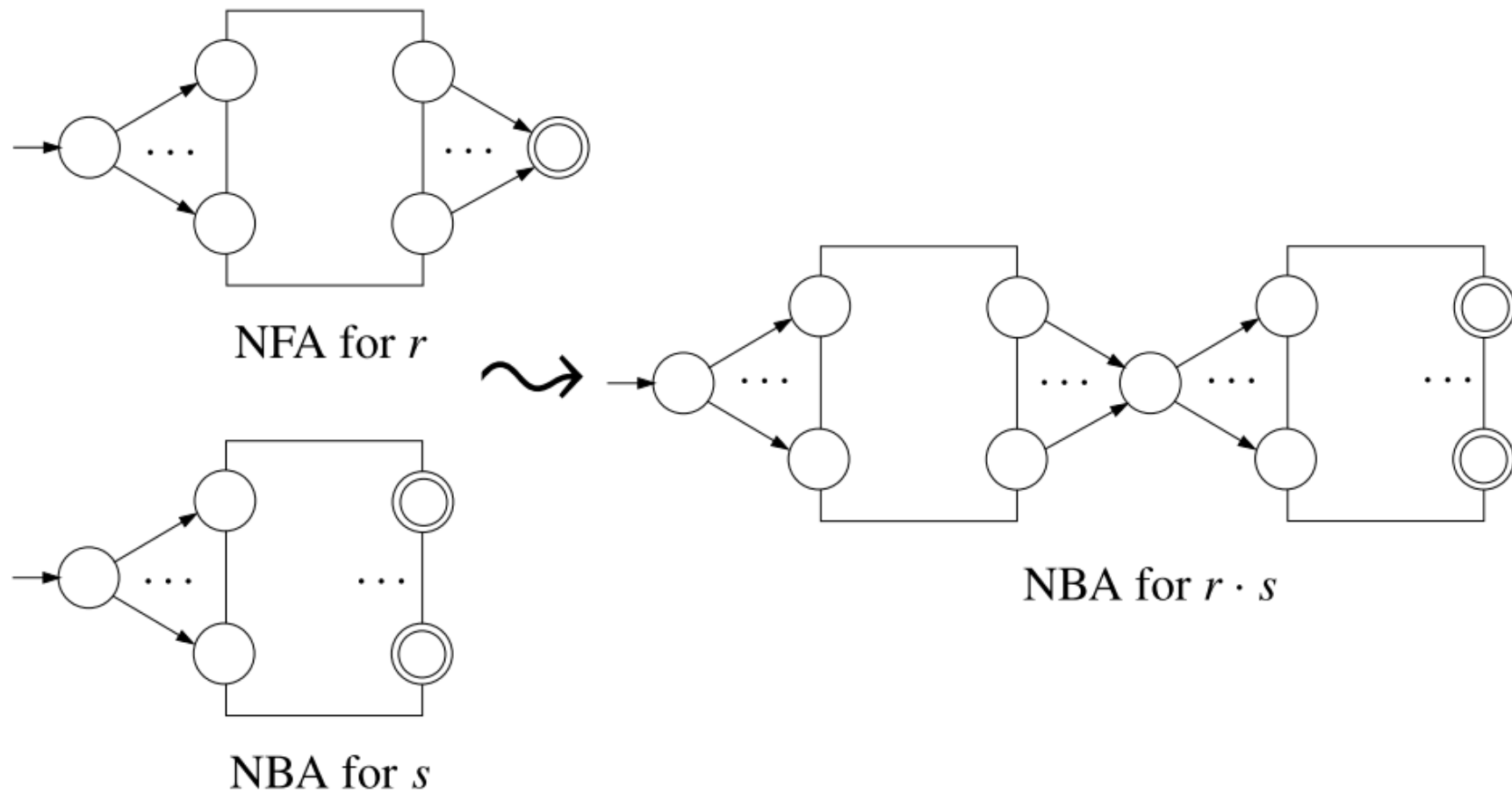

# From $\omega$ -Regular Expressions to NBAs

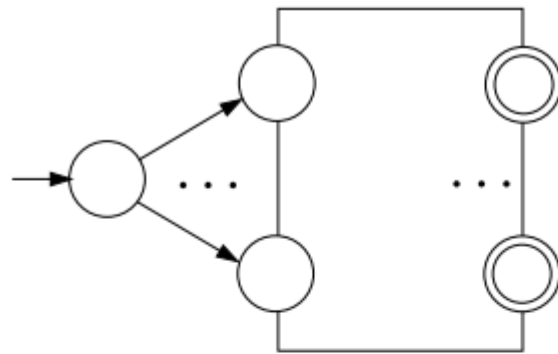

NBA for  $s_1$

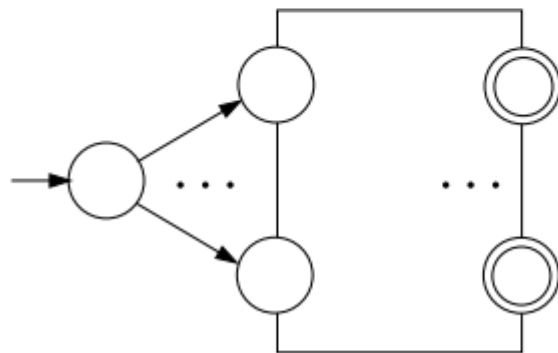

NBA for  $s_2$

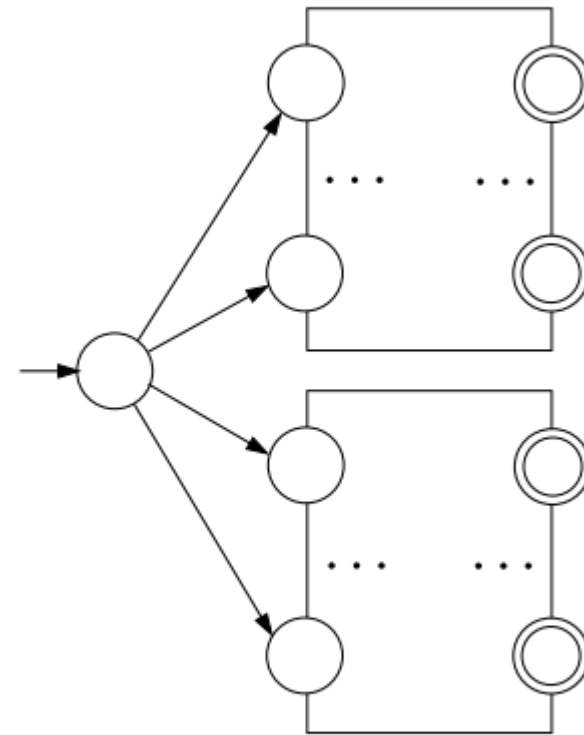

NBA for  $s_1 + s_2$

# From NBAs to $\omega$ -Regular Expressions

- **Lemma:** Let  $A$  be a NFA, and let  $q, q'$  be states of  $A$ . The language  $L_q^{q'}$  of words with runs leading from  $q$  to  $q'$  and visiting  $q'$  **exactly once** is regular.
- Let  $r_q^{q'}$  denote a regular expression for  $L_q^{q'}$ .

# From NBAs to $\omega$ -Regular Expressions

- Example:

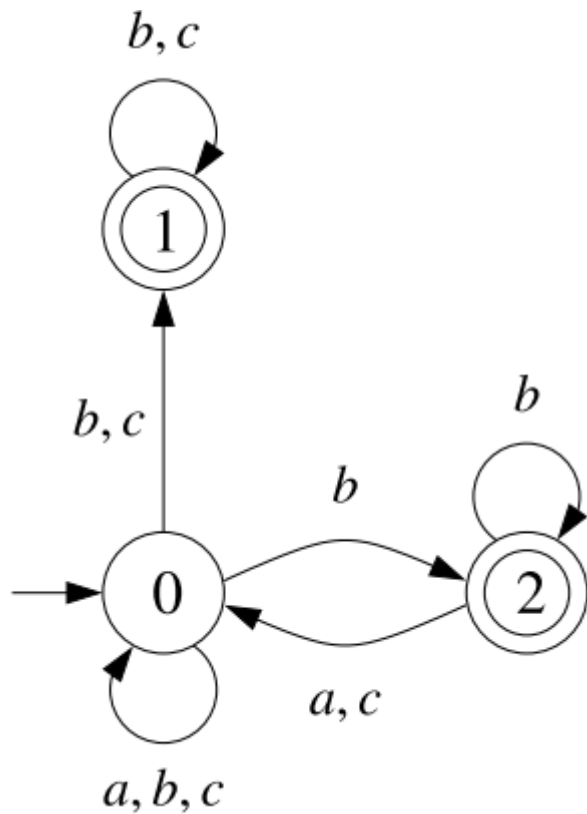

$$r_0^1 = (a + b + c)^*(b + c)$$

$$r_0^2 = (a + b + c)^*b$$

$$r_1^1 = (b + c)$$

$$r_2^2 = b + (a + c)(a + b + c)^*b$$

# From NBAs to $\omega$ -Regular Expressions

- Given a NBA  $A$ , we look at it as a NFA, and compute regular expressions  $r_q^{q'}$ .
- We show:

$$L_\omega(A) = L \left( \sum_{q \in F} r_{q_0}^q (r_q^q)^\omega \right)$$

- An  $\omega$ -word belongs to  $L_\omega(A)$  iff it is accepted by a run that starts at  $q_0$  and visits some accepting state  $q$  infinitely often.

# From NBAs to $\omega$ -Regular Expressions

- Example:

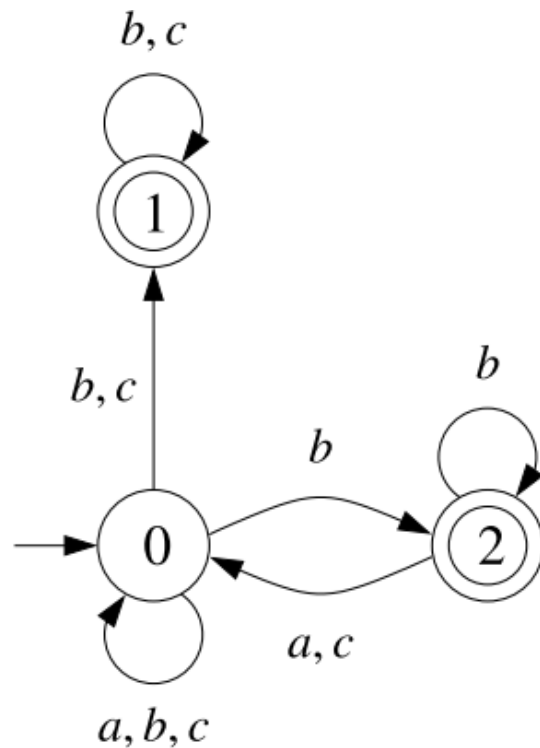

$$\begin{aligned}r_0^1 &= (a + b + c)^*(b + c) \\r_0^2 &= (a + b + c)^*b \\r_1^1 &= (b + c) \\r_2^2 &= b + (a + c)(a + b + c)^*b\end{aligned}$$

$$L_\omega(A) = r_0^1 (r_1^1)^\omega + r_0^2 (r_2^2)^\omega$$

# DBAs are less expressive than NBAs

- **Prop.:** The  $\omega$ -language  $(a + b)^* b^\omega$  is not recognized by any DBA.
- **Proof:** By contradiction. Assume some DBA recognizes  $(a + b)^* b^\omega$ .
  - DBA accepts  $b^\omega$  → DFA accepts  $b^{n_0}$
  - DBA accepts  $b^{n_0} a b^\omega$  → DFA accepts  $b^{n_0} a b^{n_1}$
  - DBA accepts  $b^{n_0} a b^{n_1} a b^\omega$  → DFA accepts  $b^{n_0} a b^{n_1} a b^{n_2}$  etc.
  - By determinism and finite number of states, the DBA accepts  $b^{n_0} a b^{n_1} a b^{n_2} \dots a b^{n_i} (a b^{n_{i+1}} \dots a b^{n_j})^\omega$  which does not belong to  $(a + b)^* b^\omega$ .

# Generalized Büchi Automata

- Same power as Büchi automata, but more adequate for some constructions.
- Several sets of accepting states.
- A run is **accepting** if it visits **each set of accepting states** infinitely often.

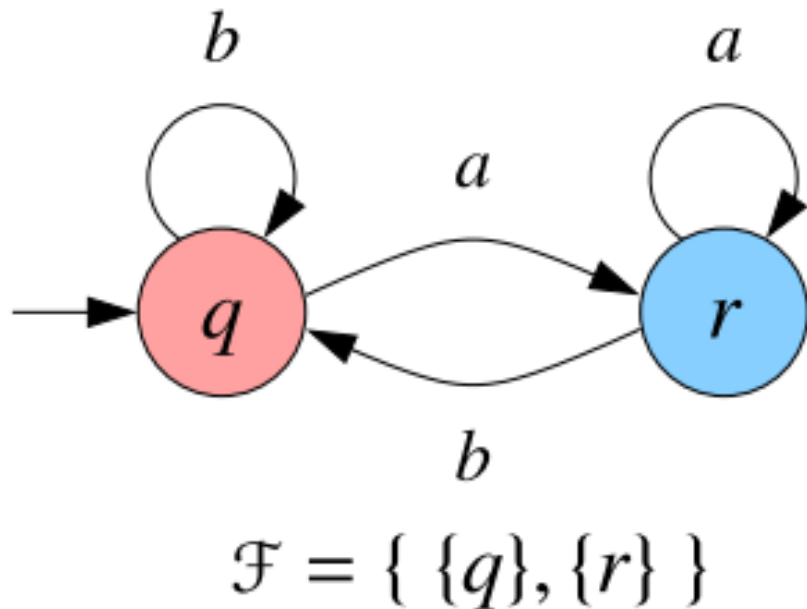



# From NGAs to NBAs

- Important fact:

All the sets  $F_1, \dots, F_n$  are visited infinitely often

is equivalent to

$F_1$  is eventually visited

and

every visit to  $F_i$  is eventually followed by a visit to  $F_{i \oplus 1}$

# From NGAs to NBAs

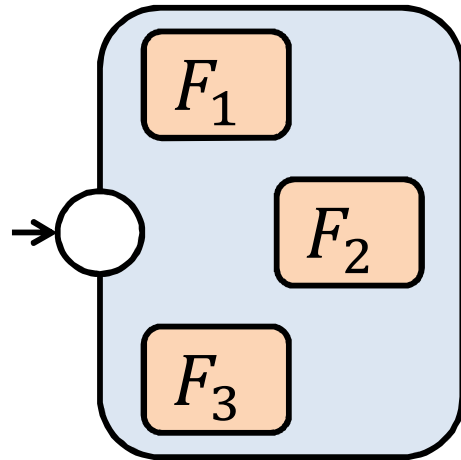

NFA with 3 sets of accepting states

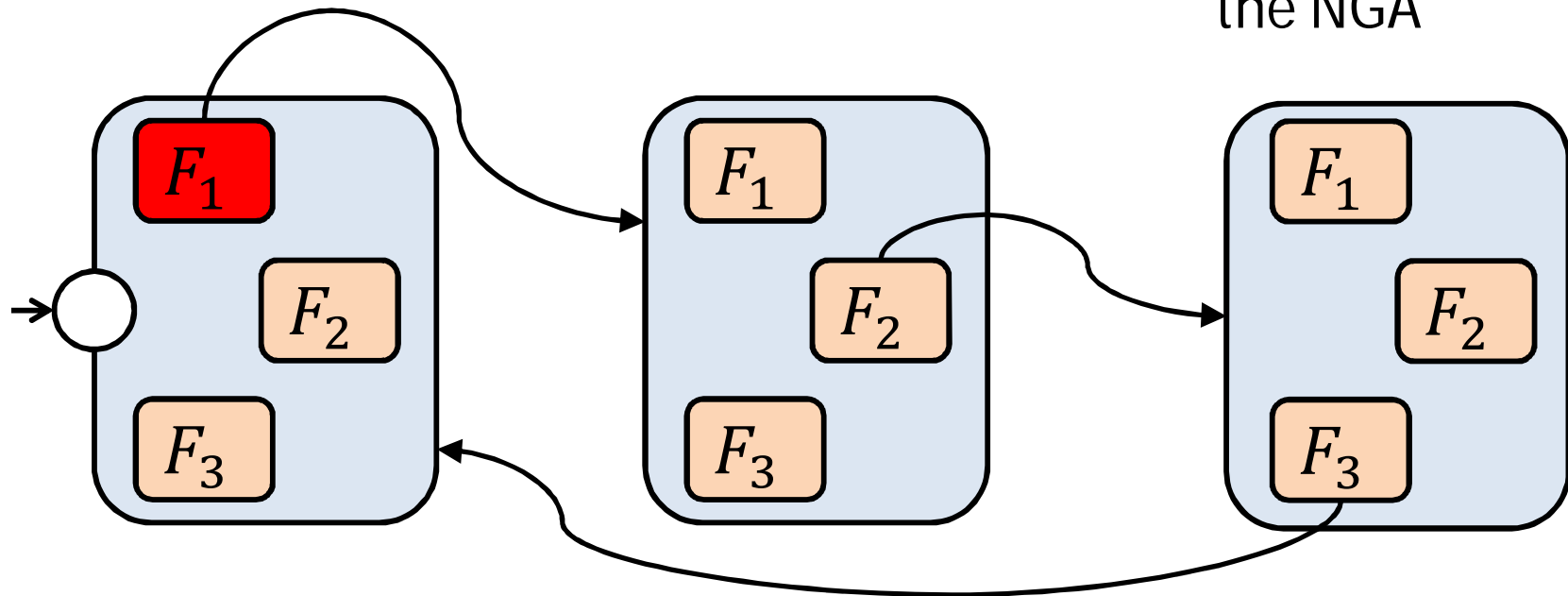

Equivalent NBA  
with 3 copies of  
the NFA

*NGAtoNBA(A)*

**Input:** NGA  $A = (Q, \Sigma, Q_0, \delta, \mathcal{F})$ , where  $\mathcal{F} = \{F_0, \dots, F_{m-1}\}$

**Output:** NBA  $A' = (Q', \Sigma, \delta', Q'_0, F')$

```
1   $Q', \delta', F' \leftarrow \emptyset; Q'_0 \leftarrow \{[q_0, 0] \mid q_0 \in Q_0\}$ 
2   $W \leftarrow Q'_0$ 
3  while  $W \neq \emptyset$  do
4    pick  $[q, i]$  from  $W$ 
5    add  $[q, i]$  to  $Q'$ 
6    if  $q \in F_0$  and  $i = 0$  then add  $[q, i]$  to  $F'$ 
7    for all  $a \in \Sigma, q' \in \delta(q, a)$  do
8      if  $q \notin F_i$  then
9        if  $[q', i] \notin Q'$  then add  $[q', i]$  to  $W$ 
10       add  $([q, i], a, [q', i])$  to  $\delta'$ 
11     else  $/* q \in F_i */$ 
12       if  $[q', i \oplus 1] \notin Q'$  then add  $[q', i \oplus 1]$  to  $W$ 
13       add  $([q, i], a, [q', i \oplus 1])$  to  $\delta'$ 
14  return  $(Q', \Sigma, \delta', Q'_0, F')$ 
```

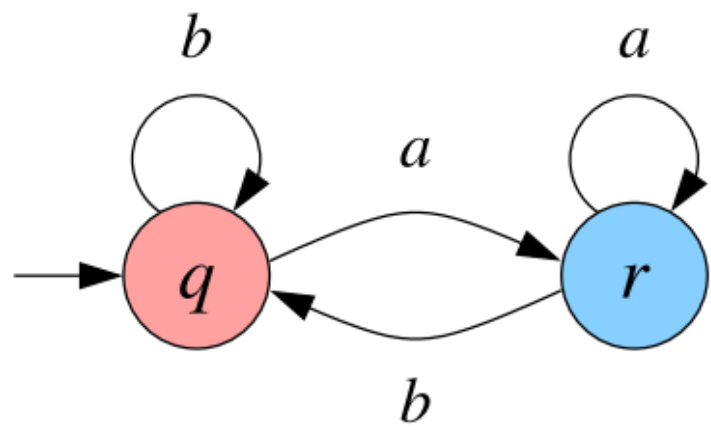

$$\mathcal{F} = \{ \{q\}, \{r\} \}$$

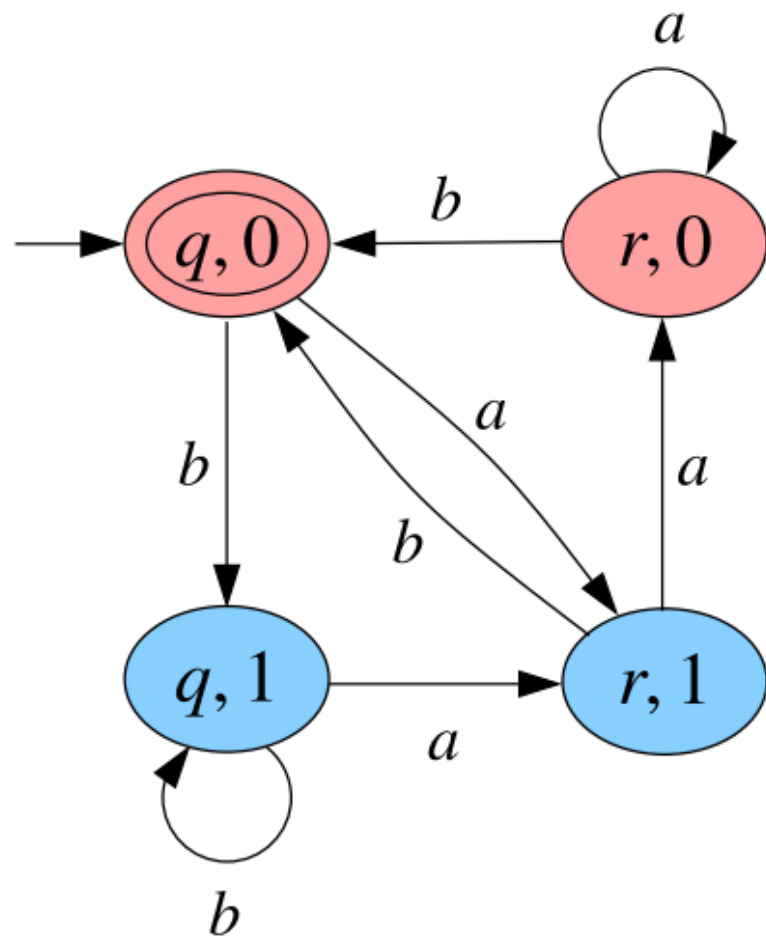

DGAs have the same expressive power as DBAs, and so are not equivalent to NGAs.

- **Question:** Are there other classes of omega-automata with
  - the same expressive power as NBAs or NGAs, and
  - with equivalent deterministic and nondeterministic versions?

We are only willing to change the acceptance condition!

# Co-Büchi automata

- A **nondeterministic co-Büchi automaton (NCA)** is syntactically identical to a NBA, but a run is accepting iff it only visits accepting states **finitely often**.

# Which are the languages?

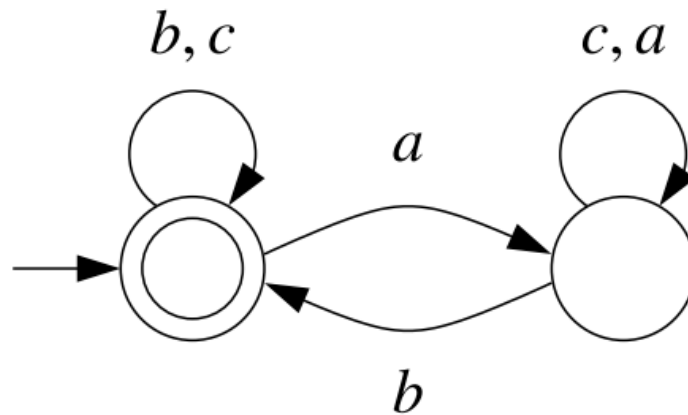
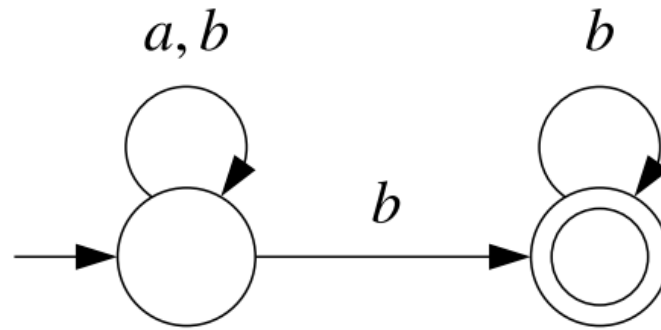
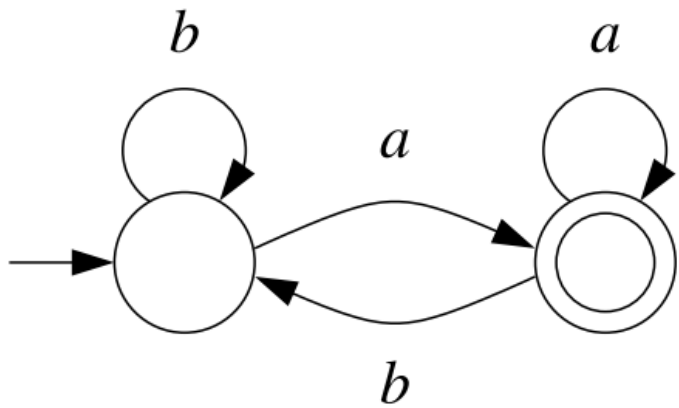

# Determinizing co-Büchi automata

- Given a NCA  $A$  we construct a DCA  $B$  such that  $L(A) = L(B)$ .
- We proceed in three steps:
  - We assign to every  $\omega$ -word  $w$  a **directed acyclic graph  $dag(w)$**  that “contains” all runs of  $A$  on  $w$ .
  - We prove that  $w$  is accepted by  $A$  iff  $dag(w)$  is infinite but contains only finitely many **breakpoints**.
  - We construct a DCA  $B$  that accepts an  $\omega$ -word  $w$  iff  $dag(w)$  is infinite and contains finitely many breakpoints.



- Running example:

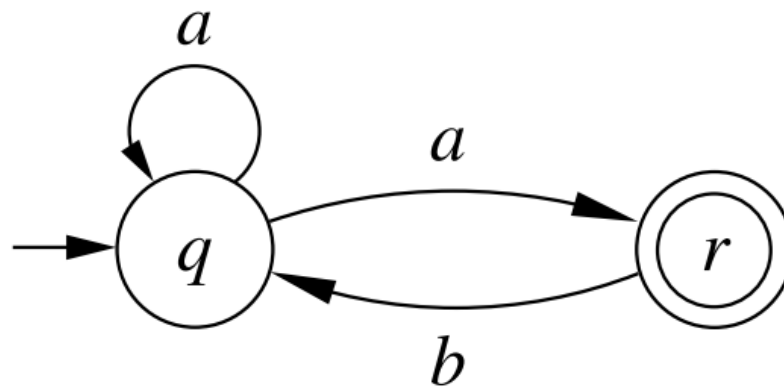

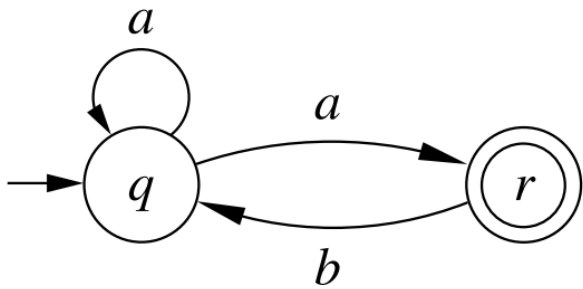

$dag(aba^\omega)$

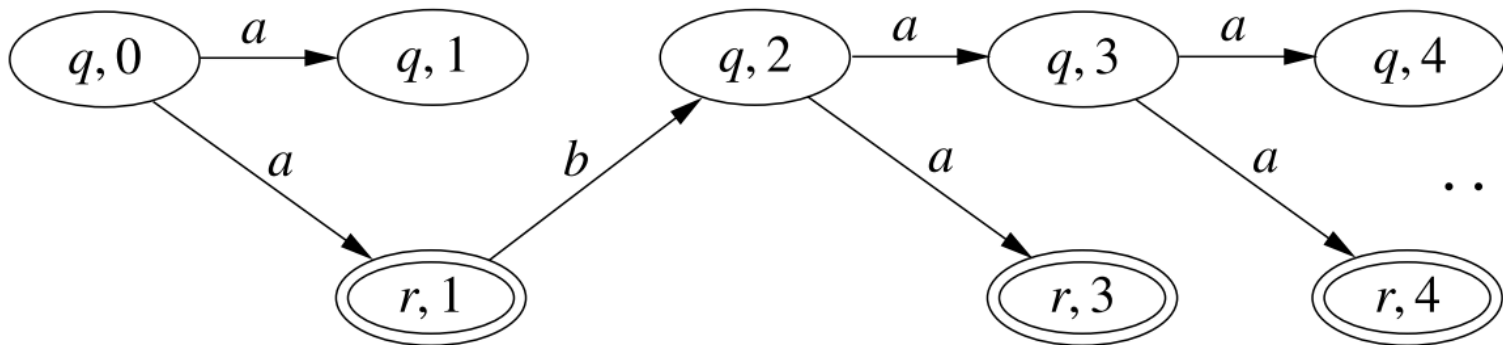

$dag((ab)^\omega)$

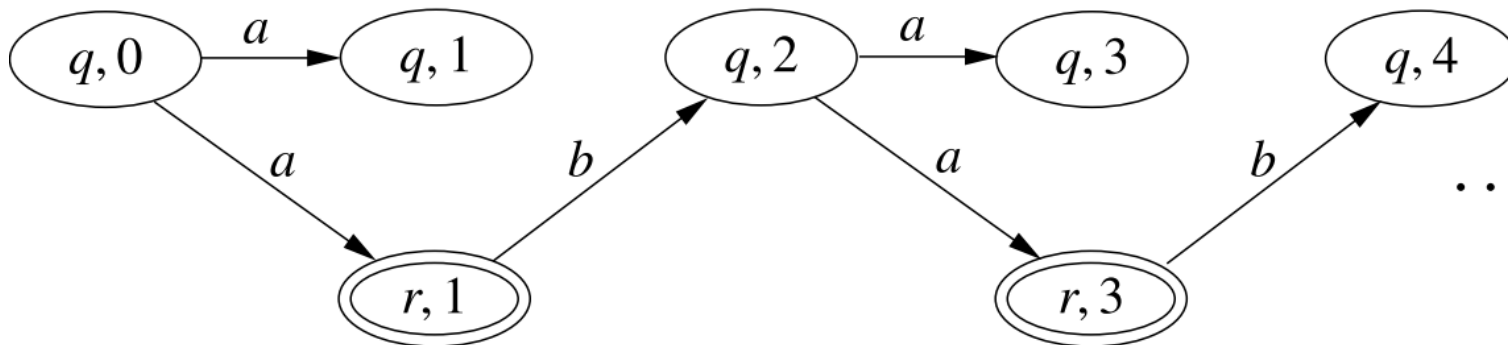

- $A$  accepts  $w$  iff some infinite path of  $dag(w)$  only visits accepting states finitely often

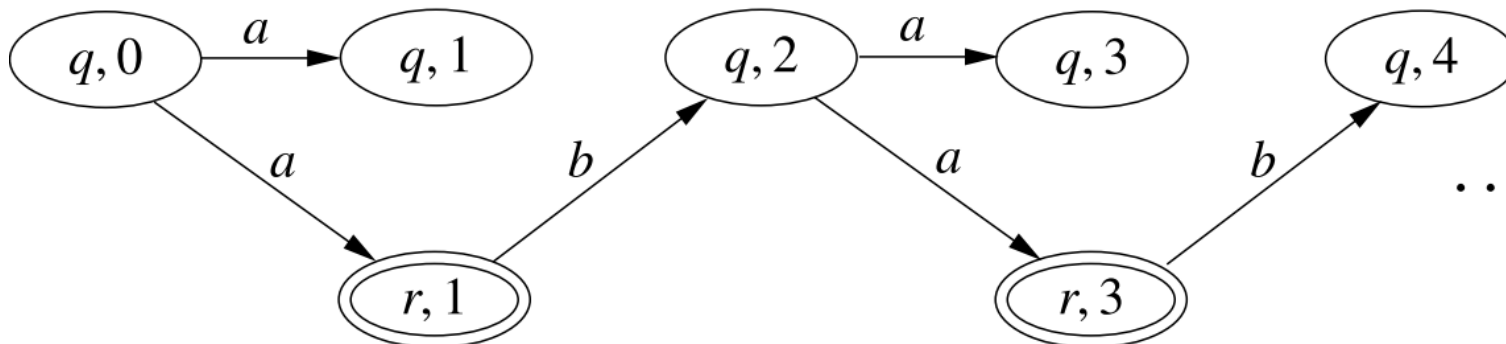
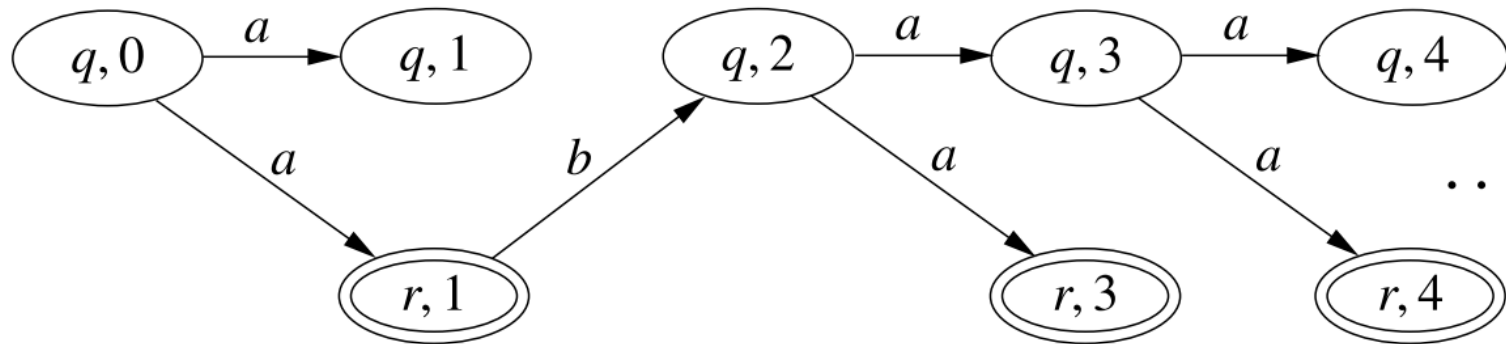

# Levels of a *dag*

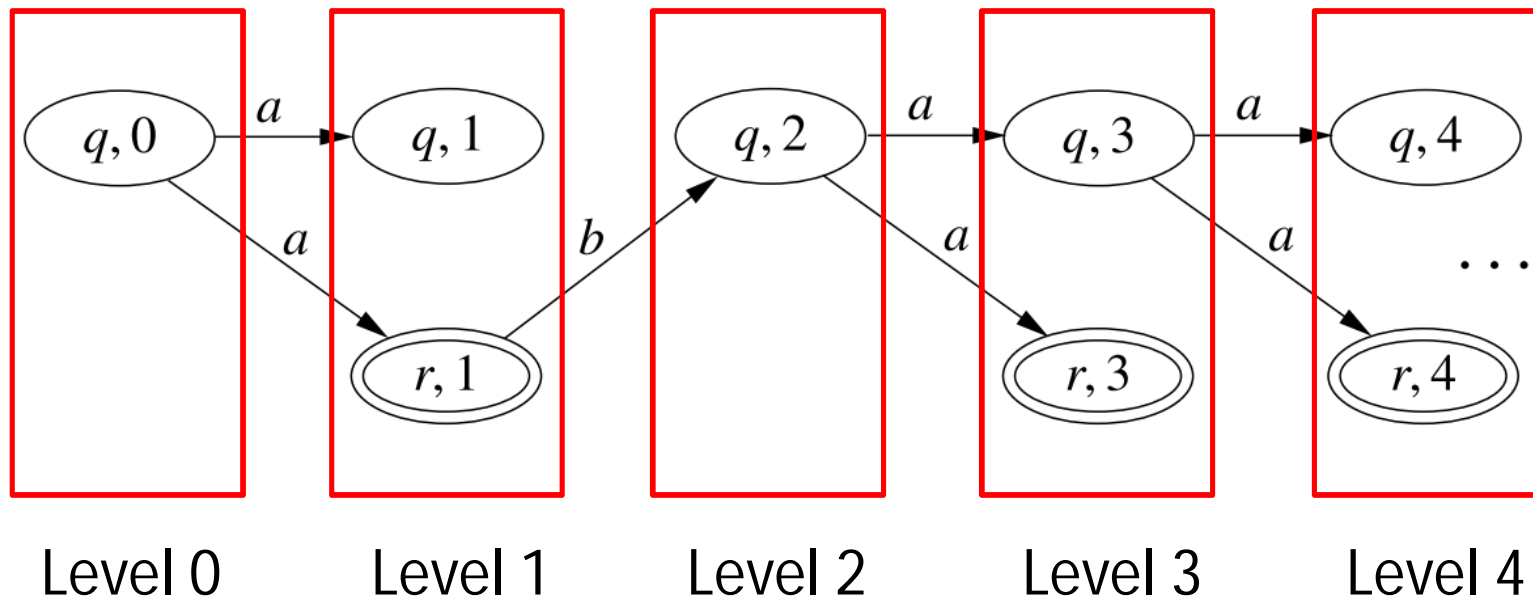

# Breakpoints of a *dag*

- We defined inductively the set of levels that are breakpoints:
  - Level 0 is always a breakpoint
  - If level  $l$  is a breakpoint, then the next level  $l'$  such that **every path** between  $l$  and  $l'$  visits an accepting state is also a breakpoint.

Only two breakpoints

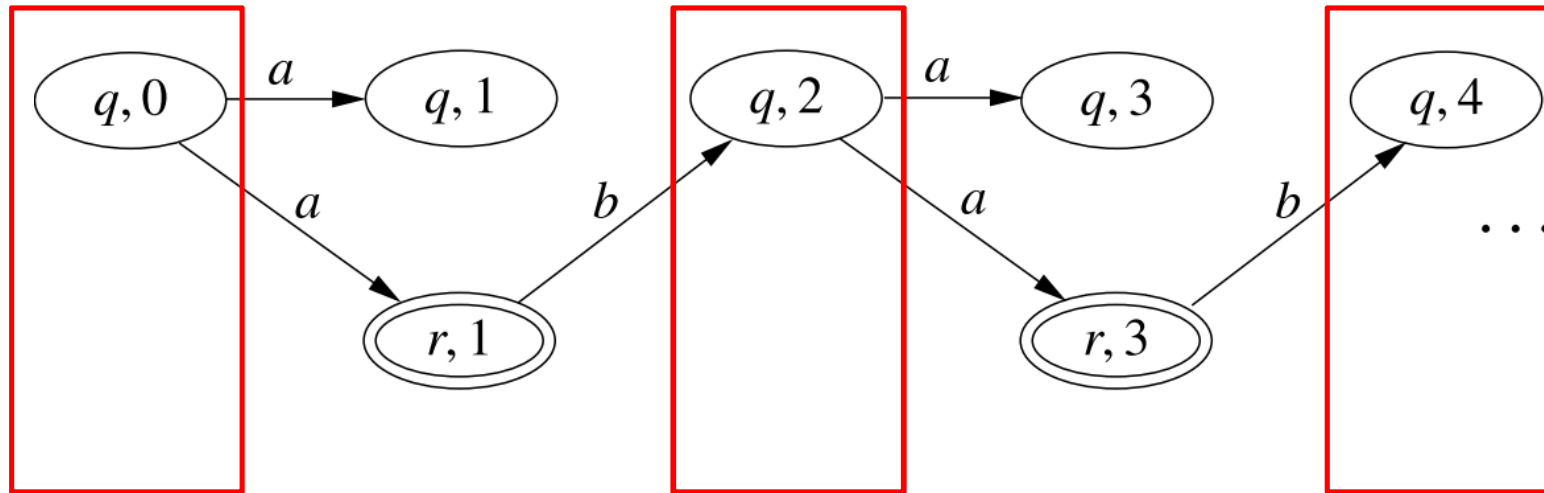
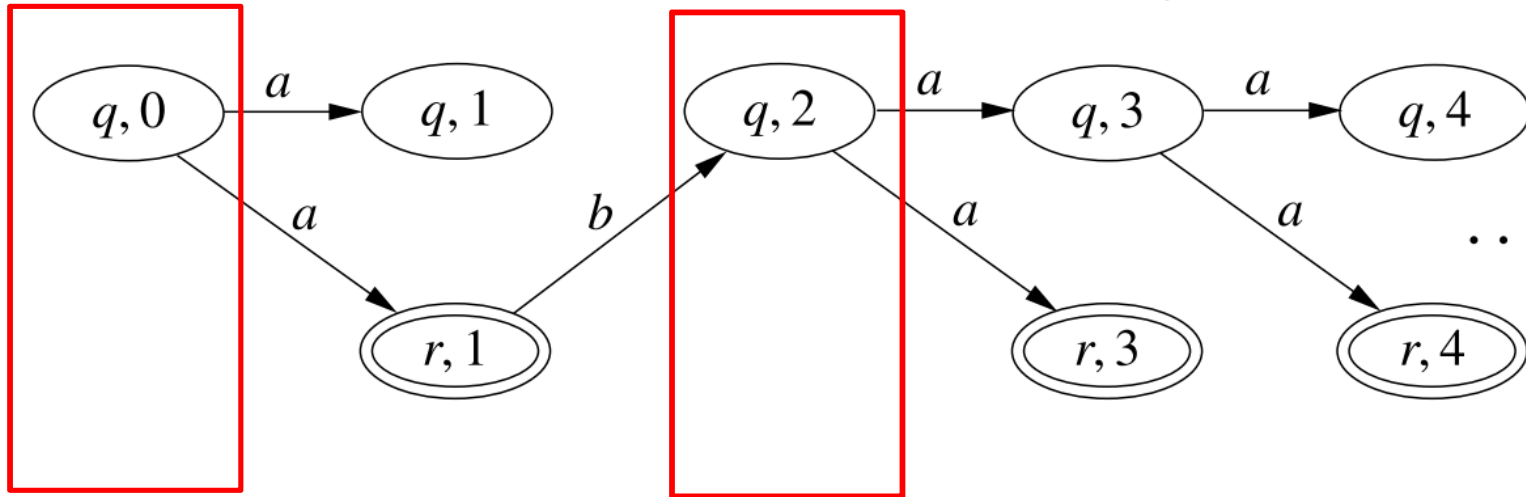

Infinitely many breakpoints

**Lemma:**  $A$  accepts  $w$  iff  $dag(w)$  is infinite and has only finitely many breakpoints.

**Proof:**

If  $A$  accepts  $w$ , then it has at least one run on  $w$ , and so  $dag(w)$  is infinite. Moreover, the run visits accepting states only finitely often, and so after it stops visiting accepting states there are no further breakpoints.

If  $dag(w)$  is infinite, then it has an infinite path, and so  $A$  has at least one run on  $w$ . Since  $dag(w)$  has finitely many breakpoints, then some infinite path visits accepting states only finitely often.

# Constructing the DCA

- If we could tell if a level is a breakpoint by looking at it, we could take the set of breakpoints as states of the DCA.
- However, we also need some information about its ``history``.
- Solution: add that information to the level!



# Constructing the DCA

- States: pairs  $[P, O]$  where:
  - $P$  is the set of states of a level, and
  - $O \subseteq P$  is the set of states “that owe a visit to the set of accepting states”.
- Formally:  $q \in O$  if  $q$  is the endpoint of a path starting at the last breakpoint that has not yet visited any accepting state.

# Constructing the DCA

- **States:** pairs  $[P, O]$
- **Initial state:** pair  $[\{q_0\}, \emptyset]$  if  $q_0 \in F$ , and  $[\{q_0\}, \{q_0\}]$  otherwise.
- **Transitions:**  $\delta([P, Q], a) = [P', O']$  where  $P' = \delta(P, a)$ , and
  - $O' = \delta(O, a) \setminus F$  if  $O \neq \emptyset$   
(automaton updates set of owing states)
  - $O' = \delta(P, a) \setminus F$  if  $O = \emptyset$   
(automaton starts search for next breakpoint)
- **Accepting states:** pairs  $[P, \emptyset]$  (no owing states)

*NCAtoDCA(A)*

**Input:** NCA  $A = (Q, \Sigma, \delta, q_0, F)$

**Output:** DCA  $B = (\tilde{Q}, \Sigma, \tilde{\delta}, \tilde{q}_0, \tilde{F})$  with  $L_\omega(A) = \overline{B}$

```
1   $\tilde{Q}, \tilde{\delta}, \tilde{F} \leftarrow \emptyset$ ; if  $q_0 \in F$  then  $\tilde{q}_0 \leftarrow [q_0, \emptyset]$  else  $\tilde{q}_0 \leftarrow [\{q_0\}, \{q_0\}]$ 
2   $W \leftarrow \{ \tilde{q}_0 \}$ 
3  while  $W \neq \emptyset$  do
4      pick  $[P, O]$  from  $W$ ; add  $[P, O]$  to  $\tilde{Q}$ 
5      if  $P = \emptyset$  then add  $[P, O]$  to  $\tilde{F}$ 
6      for all  $a \in \Sigma$  do
7           $P' = \delta(P, a)$ 
8          if  $O \neq \emptyset$  then  $O' \leftarrow \delta(O, a) \setminus F$  else  $O' \leftarrow \delta(P, a) \setminus F$ 
9          add  $([P, O], a, [P', O'])$  to  $\tilde{\delta}$ 
10         if  $[P', O'] \notin \tilde{Q}$  then add  $[P', O']$  to  $W$ 
```

- **Complexity:** at most  $3^n$  states

# Running example

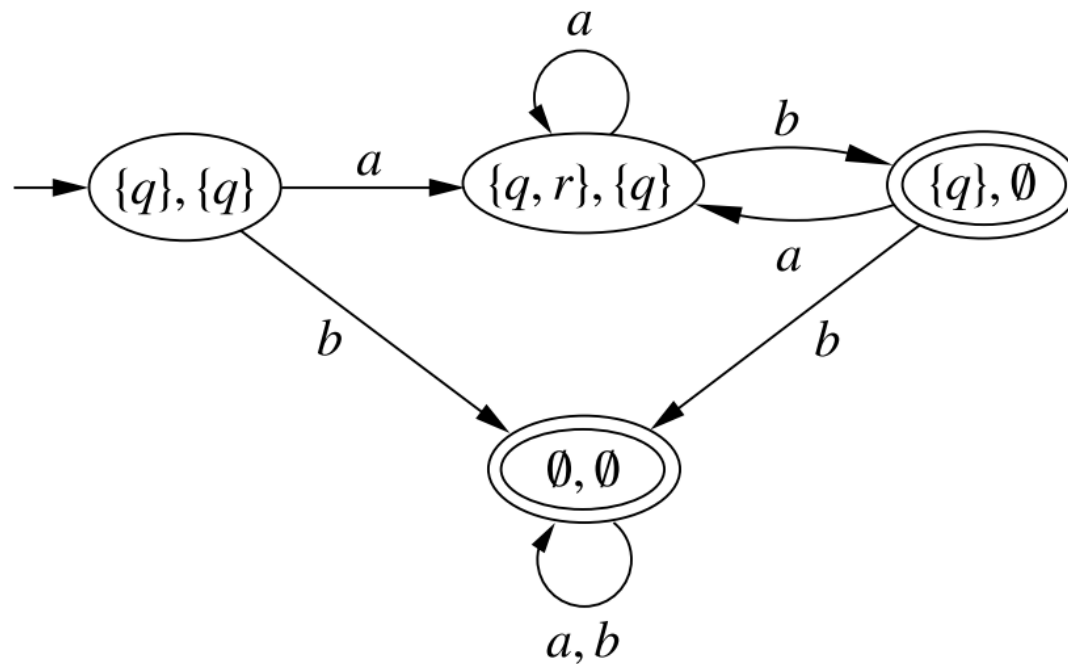
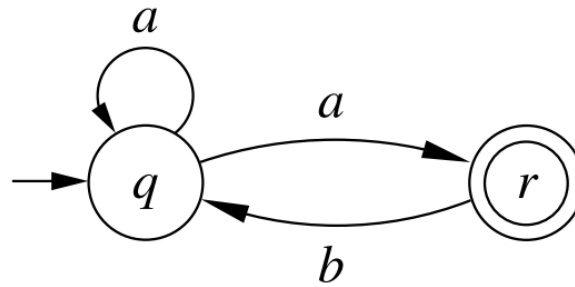

# Recall ...

- **Question:** Are there other classes of omega-automata with
  - the same expressive power as NBAs or NGAs, and
  - with equivalent deterministic and nondeterministic versions?

Are co-Büchi automata a positive answer?

# Unfortunately no ...

**Lemma:** No DCA recognizes the language  $(b^*a)^\omega$ .

**Proof:** Assume the contrary. Then the same automaton seen as a DBA recognizes the complement  $(a + b)^*b^\omega$ . Contradiction.

So the quest goes on ...

# Muller automata

- A nondeterministic Muller automaton (NMA) has a **collection**  $\{F_0, F_1, \dots, F_{m-1}\}$  of sets of accepting states.
- A run is accepting if the set of states it visits infinitely often is **equal** to one of the sets in the collection.

# From Büchi to Muller automata

- Let  $A$  be a NBA with set  $F$  of accepting states.
- A set of states of  $A$  is **good** if it contains some state of  $F$ .
- Let  $\mathcal{G}$  be the set of all good sets of  $A$ .
- Let  $A'$  be "the same automaton" as  $A$ , but with Muller condition  $\mathcal{G}$ .
- Let  $\rho$  be an arbitrary run of  $A$  and  $A'$ . We have
  - $\rho$  is accepting in  $A$
  - iff  $\text{inf}(\rho)$  contains some state of  $F$
  - iff  $\text{inf}(\rho)$  is a good set of  $A$
  - iff  $\rho$  is accepting in  $A'$



# From Muller to Büchi automata

- Let  $A$  be a NMA with condition  $\{F_0, F_1, \dots, F_{m-1}\}$ .
- Let  $A_0, \dots, A_{m-1}$  be NMAs with the same structure as  $A$  but Muller conditions  $\{F_0\}, \{F_1\}, \dots, \{F_{m-1}\}$  respectively.
- We have:  $L(A) = L(A_0) \cup \dots \cup L(A_{m-1})$
- We proceed in two steps:
  1. we construct for each NMA  $A_i$  an NGA  $A'_i$  such that  $L(A_i) = L(A'_i)$
  2. we construct an NGA  $A'$  such that 
$$L(A') = L(A'_0) \cup \dots \cup L(A'_{m-1})$$

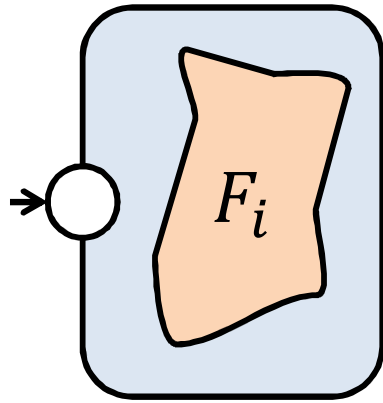

NMA

Transitions leaving  $F_i$  are duplicated and resent to the copy of  $F_i$

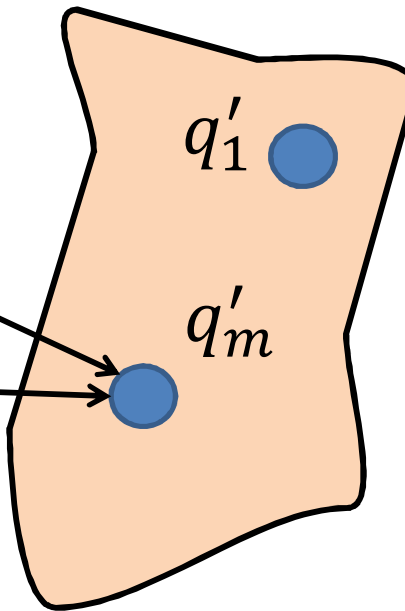
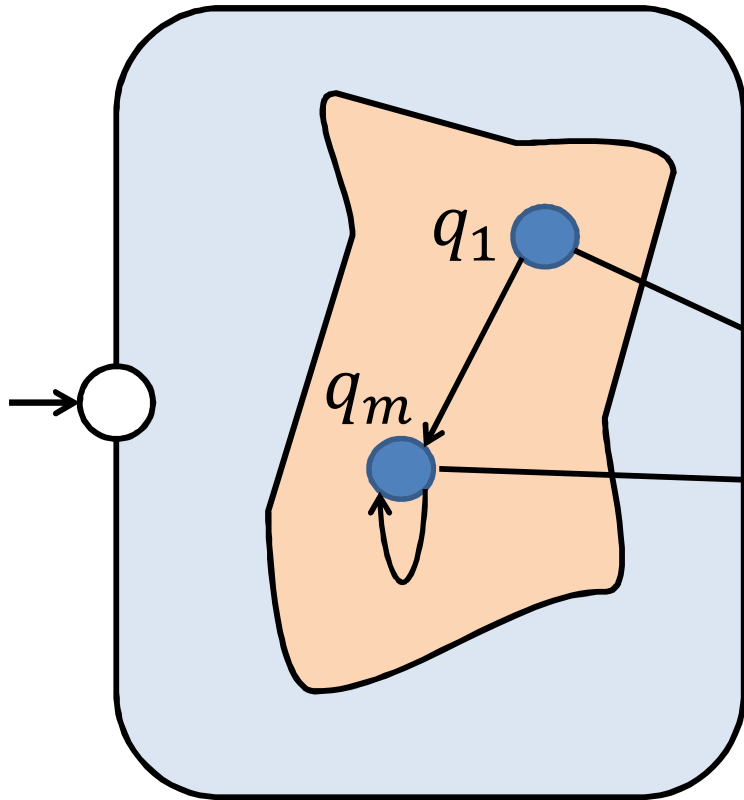

NGA with accepting condition  $\{ \{q'_1\}, \dots, \{q'_m\} \}$

*NMA to NGA(A)*

**Input:** NMA  $A = (Q, \Sigma, q_0, \delta, \{F\})$

**Output:** NGA  $A = (Q', \Sigma, q'_0, \delta', \mathcal{F}')$

```
1   $Q', \delta', \mathcal{F}' \leftarrow \emptyset$ 
2   $q'_0 \leftarrow [q_0, 0]$ 
3   $W \leftarrow \{[q_0, 0]\}$ 
4  while  $W \neq \emptyset$  do
5    pick  $[q, i]$  from  $W$ ; add  $[q, i]$  to  $Q'$ 
6    if  $q \in F$  and  $i = 1$  then add  $\{[q, 1]\}$  to  $\mathcal{F}'$ 
7    for all  $a \in \Sigma, q' \in \delta(q, a)$  do
8      if  $i = 0$  then
9        add  $([q, 0], a, [q', 0])$  to  $\delta'$ 
10       if  $[q', 0] \notin Q'$  then add  $[q', 0]$  to  $W$ 
11       if  $q' \in F$  then
12         add  $([q, 0], a, [q', 1])$  to  $\delta'$ 
13         if  $[q', 1] \notin Q'$  then add  $[q', 1]$  to  $W$ 
14       else /*  $i = 1$  */
15         if  $q' \in F$  then
16           add  $([q, 1], a, [q', 1])$  to  $\delta'$ 
17           if  $[q', 1] \notin Q'$  then add  $[q', 1]$  to  $W$ 
18  return  $(Q', \Sigma, q'_0, \delta', \mathcal{F}')$ 
```

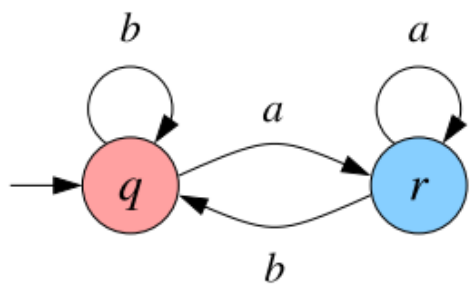

$$\mathcal{F} = \{F_0, F_1\}$$

$$F_0 = \{q\}$$

$$F_1 = \{r\}$$

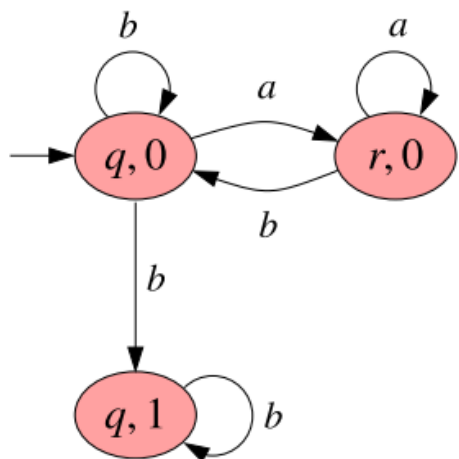

$$\mathcal{F}'_0 = \{[q, 1]\}$$

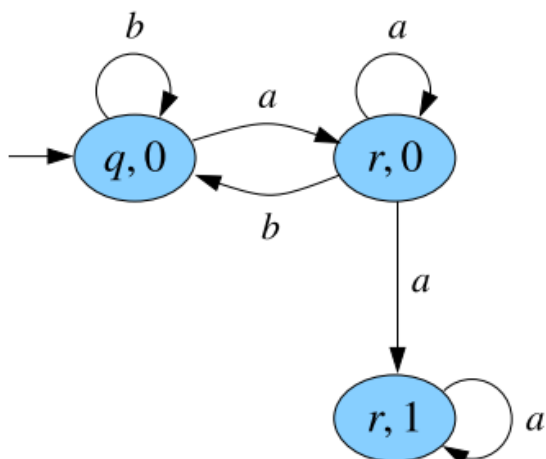

$$\mathcal{F}'_1 = \{[r, 1]\}$$

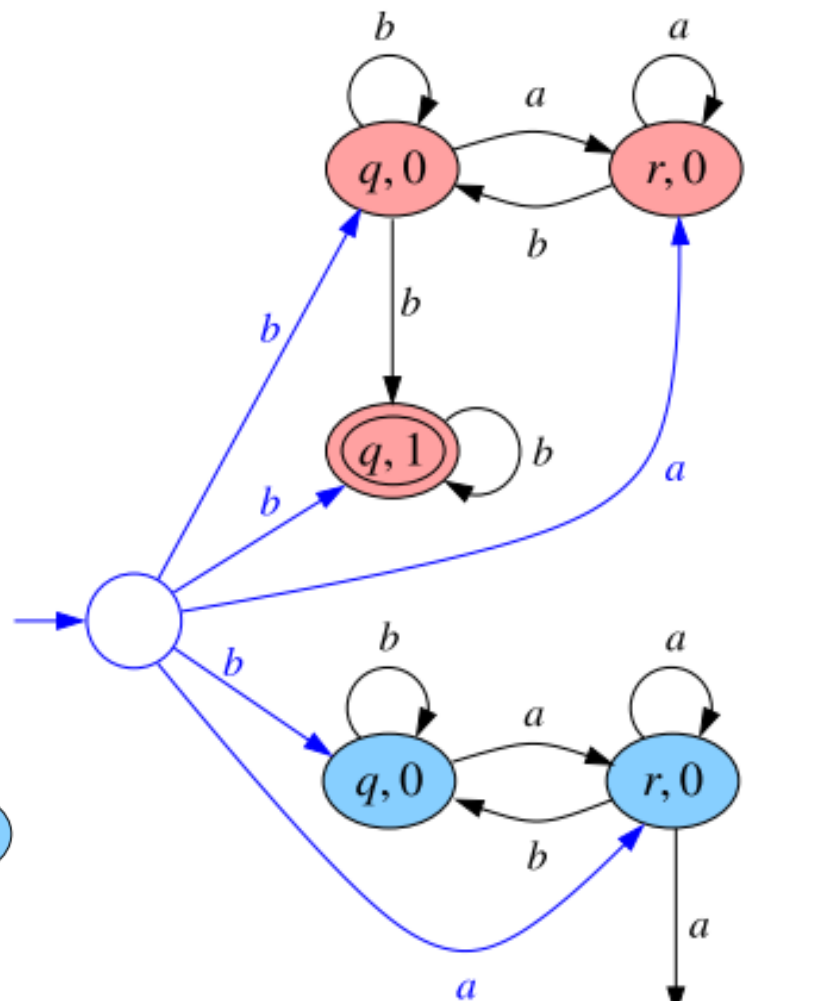

# Equivalence of NMAs and DMAs

- **Theorem (Safra):** Any NBA with  $n$  states can be effectively transformed into a DMA of size  $n^{O(n)}$ .

**Proof:** Omitted.

- DMA for  $(a + b)^* b^\omega$ :

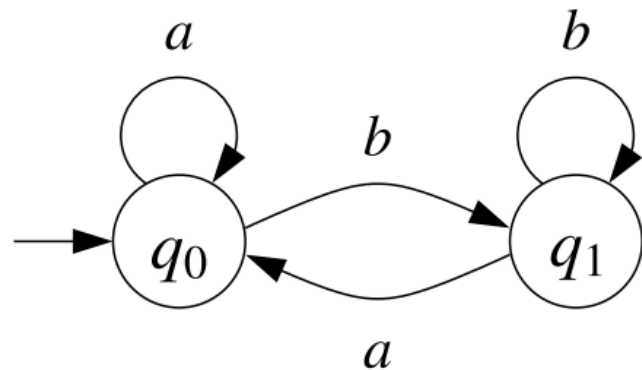

with accepting condition  
 $\{\{q_1\}\}$

- **Question:** Are there other classes of omega-automata with
  - the same expressive power as NBAs or NGAs, and
  - with equivalent deterministic and nondeterministic versions?
- **Answer:** Yes, Muller automata

# Is the quest over?

- Recall the translation  $NBA \rightarrow NMA$
- The NMA has the same structure as the NBA; its accepting conditions are all the good sets of states.
- The translation has **exponential** complexity.

**New question:** Is there a class of  $\omega$ -automata with

- the same expressive power as NBAs,
- equivalent deterministic and nondeterministic versions, and
- **polynomial conversions to and from Büchi automata?**

# Rabin automata

- The acceptance condition is a set of pairs  $\{ \langle F_0, G_0 \rangle, \dots, \langle F_{m-1}, G_{m-1} \rangle \}$
- A run  $\rho$  is accepting if there is a pair  $\langle F_i, G_i \rangle$  such that  $\rho$  visits the set  $F_i$  infinitely often and the set  $G_i$  finitely often.
- Translations NBA  $\rightarrow$  NRA and NRA  $\rightarrow$  NBA are left as an exercise.
- **Theorem (Safra)**: Any NBA with  $n$  states can be effectively transformed into a DRA with  $n^{O(n)}$  states and  $O(n)$  accepting pairs.



# Is the quest over?

- The accepting condition of Rabin automata is not closed under negation: the negation of
$$\exists i \in \{1, \dots, m\}: \text{inf}(\rho) \cap F_i \neq \emptyset \wedge \text{inf}(\rho) \cap G_i = \emptyset$$
is of the form
$$\forall i \in \{1, \dots, m\}: \text{inf}(\rho) \cap F_i = \emptyset \vee \text{inf}(\rho) \cap G_i \neq \emptyset$$
or, equivalently
$$\forall i \in \{1, \dots, m\}: \text{inf}(\rho) \cap G_i = \emptyset \Rightarrow \text{inf}(\rho) \cap F_i = \emptyset$$
- This is the **Streett condition**.
- The Büchi condition is a special case of the Streett condition.
- However, the translation from Streett to Büchi is exponential.

# Is the quest over?

**New question:** Is there a class of  $\omega$ -automata with

- the same expressive power as NBAs,
- equivalent deterministic and nondeterministic versions,
- polynomial conversions to and from Büchi automata, and
- an accepting condition closed under negation?

# Parity automata

- The acceptance condition is a sequence  $(F_1, \dots, F_{2k})$  of sets of states such that  $F_1 \subseteq F_2 \subseteq \dots \subseteq F_{2k} = Q$ .
- A run  $\rho$  is accepting if the minimal index  $i$  such that  $\rho$  visits the set  $F_i$  infinitely often is even.
- **NBA  $\rightarrow$  NPA.**  $F \rightarrow (\emptyset, F, Q, Q)$
- **NPA  $\rightarrow$  NBA.** NPA  $\rightarrow$  NRA  $\rightarrow$  NBA.
- **NPA  $\rightarrow$  NRA.**  $(F_1, \dots, F_{2k}) \rightarrow \{\langle F_{2k}, F_{2k-1} \rangle, \dots, \langle F_4, F_3 \rangle, \langle F_2, F_1 \rangle\}$
- **Theorem (Safra, Piterman):** Any NBA with  $n$  states can be effectively transformed into a DPA with  $n^{O(n)}$  states and  $O(n)$  accepting sets.
- **Complementation of DPAs.**  $(F_1, \dots, F_{2k}) \rightarrow (\emptyset, F_1, \dots, F_{2k}, Q)$

# Parity automata

**New question:** Is there a class of  $\omega$ -automata with

- the same expressive power as NBAs,
- equivalent deterministic and nondeterministic versions,
- polynomial conversions to and from Büchi automata, and
- an accepting condition closed under negation?

- **Answer:** Yes, parity automata