

Classes and conversions

Regular expressions

- Syntax: $r ::= \emptyset \mid \epsilon \mid a \mid r_1 r_2 \mid r_1 + r_2 \mid r^*$
- Semantics: The language $L(r)$ of a regular expression r is inductively defined as follows:
 - $L(\emptyset) = \emptyset, L(\epsilon) = \{\epsilon\}, L(a) = \{a\}$
 - $L(r_1 r_2) = L(r_1)L(r_2)$
where $L_1 L_2 = \{w_1 w_2 \mid w_1 \in L_1, w_2 \in L_2\}$
 - $L(r_1 + r_2) = L(r_1) \cup L(r_2)$
 - $L(r^*) = \bigcup_{i \geq 0} L^i$
where $L^0 = \{\epsilon\}$ and $L^{i+1} = L^i L$

Deterministic finite automata (DFA)

A **deterministic finite automaton** is a tuple

$A = (Q, \Sigma, \delta, q_0, F)$ where

- Q is a finite, nonempty set of **states**
- Σ is a nonempty, finite set of **letters**, called an **alphabet**
- $\delta: Q \times \Sigma \rightarrow Q$ is the **transition function**
- $q_0 \in Q$ is the **initial state**
- $F \subseteq Q$ is the set of **final states**

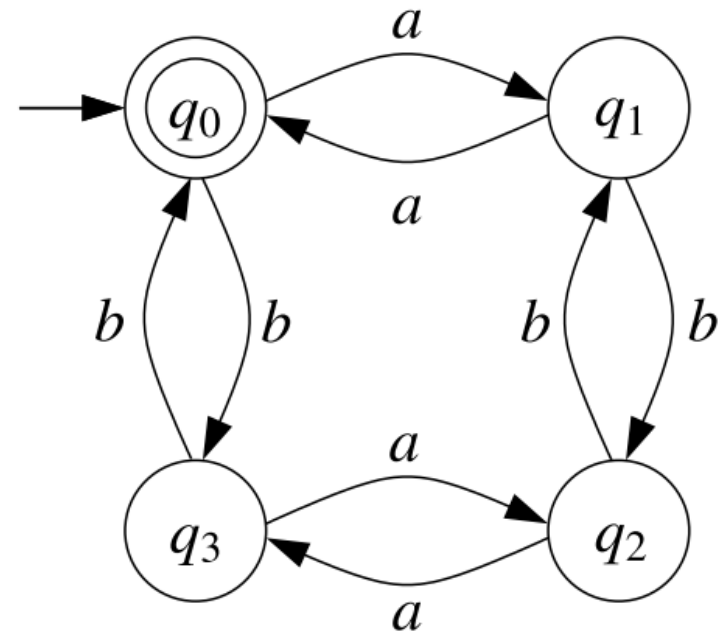

Run of a DFA on a word

- $q \xrightarrow{a} q'$ denotes $\delta(q, a) = q'$
- The **run** of a DFA on a word $a_1 a_2 \dots a_n \in \Sigma^*$ is the unique sequence $q_0 q_1 \dots q_n$ of states such that
$$q_0 \xrightarrow{a_1} q_1 \xrightarrow{a_2} q_2 \dots q_{n-1} \xrightarrow{a_n} q_n$$
- A DFA **accepts** a word iff its run on it ends in a final state. We say the run is **accepting**.
- A DFA over an alphabet Σ **recognizes** a language $L \subseteq \Sigma^*$ if it accepts every word of L and no other. The language recognized by a DFA A is denoted $L(A)$.

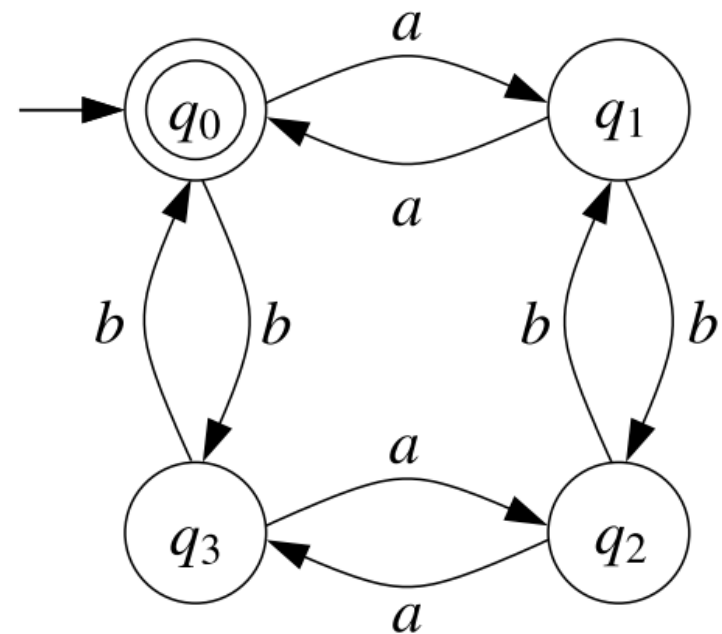

Nondeterministic finite automata (NFA)

A **nondeterministic automaton** is a tuple $A = (Q, \Sigma, \delta, Q_0, F)$ where

- Q, Σ, F are as for DFAs
- $\delta: Q \times \Sigma \rightarrow 2^Q$ is the transition function
- $Q_0 \in Q$ is the set of initial states

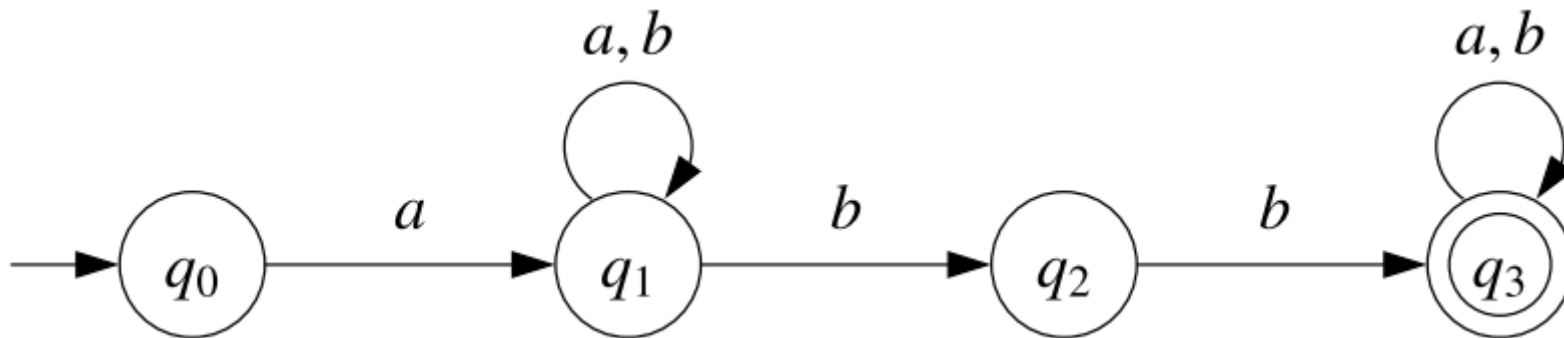

Runs of an NFA on a word

- A **run** of an NFA on a word $a_1 a_2 \dots a_n \in \Sigma^*$ is a sequence $q_0 q_1 \dots q_n$ of states such that $q_0 \in Q_0$ and

$$q_0 \xrightarrow{a_1} q_1 \xrightarrow{a_2} q_2 \cdots q_{n-1} \xrightarrow{a_n} q_n$$

- An NFA can have 0, 1, or more runs on the same word (but only finitely many).
- An NFA **accepts** a word iff at least one of its runs on it is accepting.

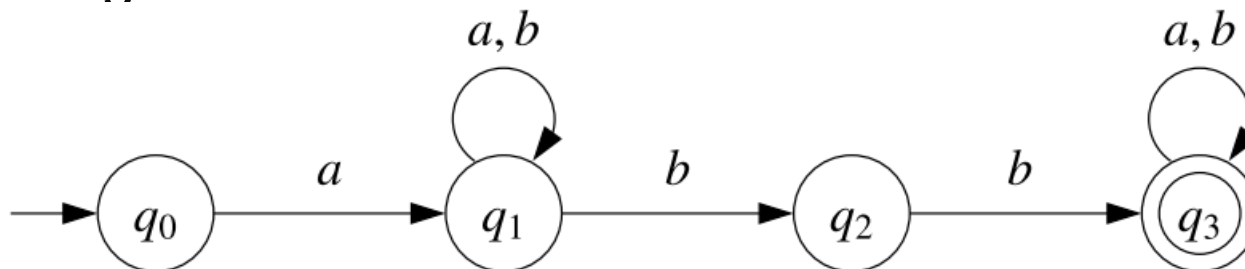

Nondeterministic finite automata with ϵ -transitions (NFA ϵ)

A **nondeterministic automaton with ϵ -transitions** is a tuple

$A = (Q, \Sigma, \delta, Q_0, F)$ where

- Q, Σ, Q_0, F are as for NFAs
- $\delta: Q \times (\Sigma \cup \{\epsilon\}) \rightarrow 2^Q$ is the transition function

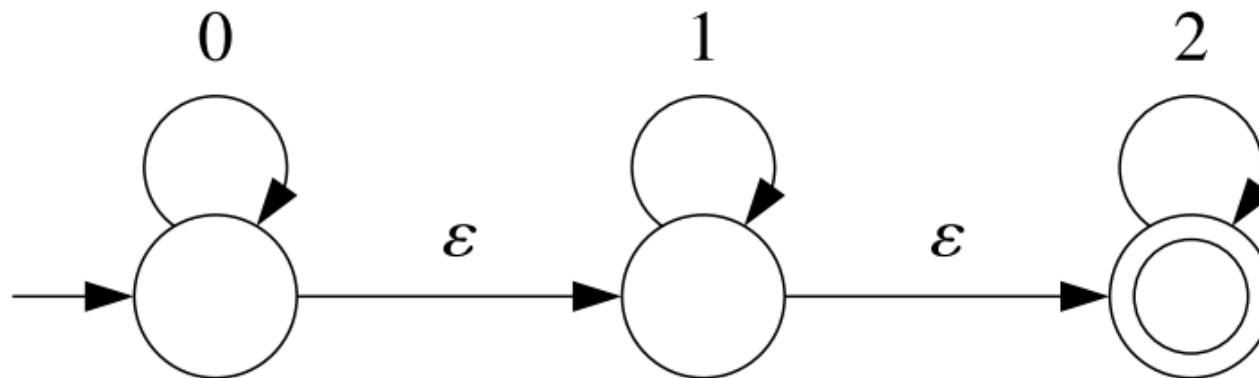

Runs of an NFA ϵ on a word

- A **run** of an NFA ϵ on a word $a_1 a_2 \dots a_n \in \Sigma^*$ is a sequence $q_0 \dots q'_0 q_1 \dots q'_1 q_2 \dots q'_{n-1} q_n \dots q'_n$ of states such that $q_0 \in Q_0$ and

$$q_0 \xrightarrow{\epsilon} \dots \xrightarrow{\epsilon} q'_0 \xrightarrow{a_1} q_1 \xrightarrow{\epsilon} \dots \xrightarrow{\epsilon} q'_1 \xrightarrow{a_2} q_2 \dots q'_{n-1} \xrightarrow{a_n} q_n \xrightarrow{\epsilon} \dots \xrightarrow{\epsilon} q'_n$$

- An NFA ϵ can have 0, 1, or more runs on the same word, even infinitely many.
- An NFA ϵ **accepts** a word iff at least one of its runs on it is accepting.

Nondeterministic finite automata with regular expressions (NFAreg)

A **nondeterministic automaton with regular expressions** is a tuple $A = (Q, \Sigma, \delta, Q_0, F)$ where

- Q, Σ, Q_0, F are as for NFAs
- $\delta: Q \times (\Sigma \cup \text{Reg}(\Sigma)) \rightarrow 2^Q$ is the transition function, where $\delta(q, r) = \emptyset$ for all but finitely many pairs $(q, r) \in Q \times (\Sigma \cup \text{Reg}(\Sigma))$

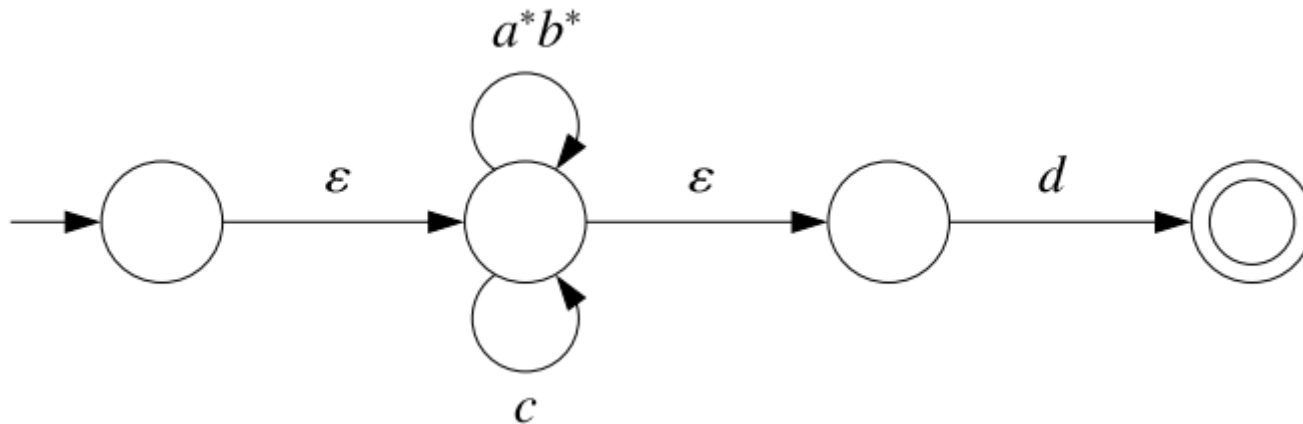

Language recognized by an NFArege

An NFArege accepts a word w if there are states q_0, \dots, q_n and regular expressions r_1, \dots, r_n such that

- $q_0 \in Q_0$, $q_n \in F$,
- $q_0 \xrightarrow{r_1} q_1 \xrightarrow{r_2} q_2 \cdots q_{n-1} \xrightarrow{r_n} q_n$, and
- $w \in L(r_1 r_2 \cdots r_n)$.

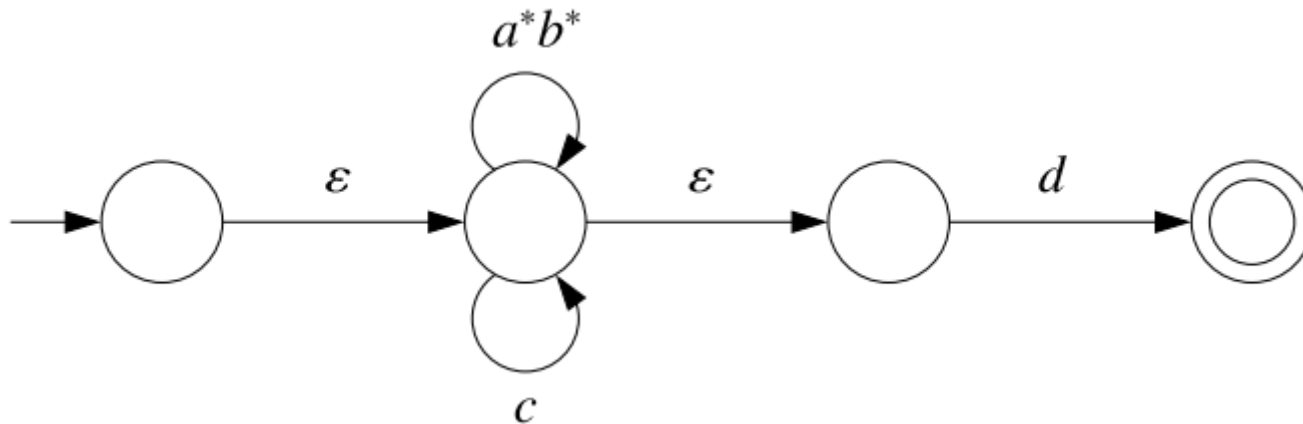

Normal form

- An automaton of any class is in **normal form** if every state is reachable by a path of transitions from some initial state.
- For every automaton there is an equivalent automaton in normal form.
- All algorithms in this course assume that automata inputs are in normal form, and guarantee that the output is also in normal form.

Conversions

NFA to DFA

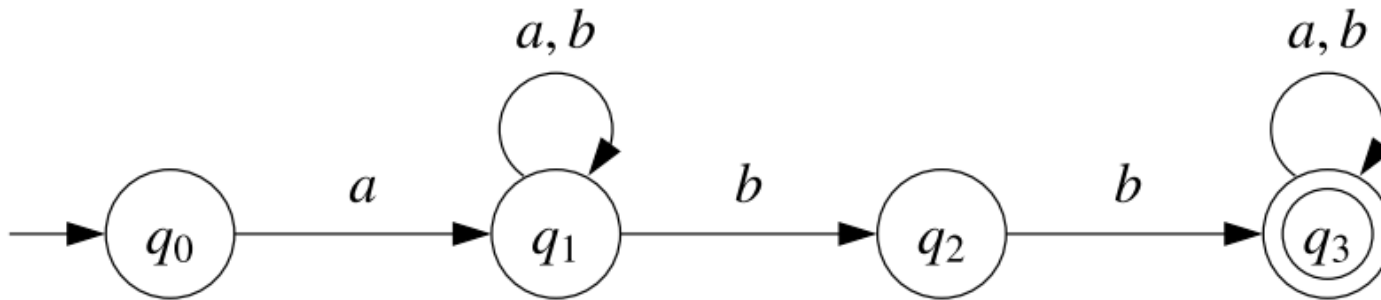

The powerset construction

NFAtoDFA(A)

Input: NFA $A = (Q, \Sigma, \delta, Q_0, F)$

Output: DFA $B = (\mathcal{Q}, \Sigma, \Delta, q_0, \mathcal{F})$ with $L(B) = L(A)$

- 1 $\mathcal{Q}, \Delta, \mathcal{F} \leftarrow \emptyset; q_0 \leftarrow Q_0$
- 2 $\mathcal{W} = \{Q_0\}$
- 3 **while** $\mathcal{W} \neq \emptyset$ **do**
- 4 **pick** Q' **from** \mathcal{W}
- 5 **add** Q' **to** \mathcal{Q}
- 6 **if** $Q' \cap F \neq \emptyset$ **then add** Q' **to** \mathcal{F}
- 7 **for all** $a \in \Sigma$ **do**
- 8 $Q'' \leftarrow \bigcup_{q \in Q'} \delta(q, a)$
- 9 **if** $Q'' \notin \mathcal{Q}$ **then add** Q'' **to** \mathcal{W}
- 10 **add** (Q', a, Q'') **to** Δ

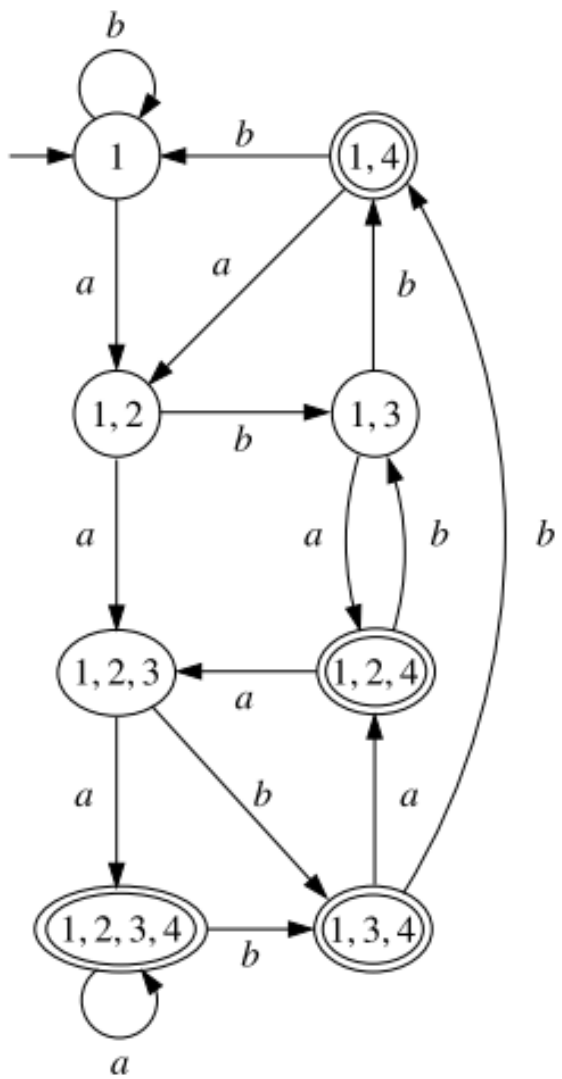
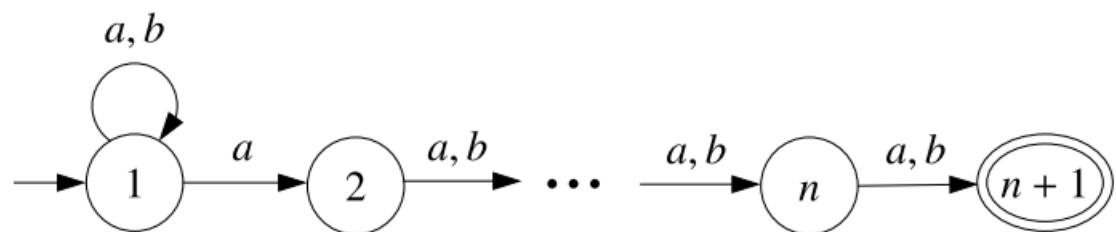

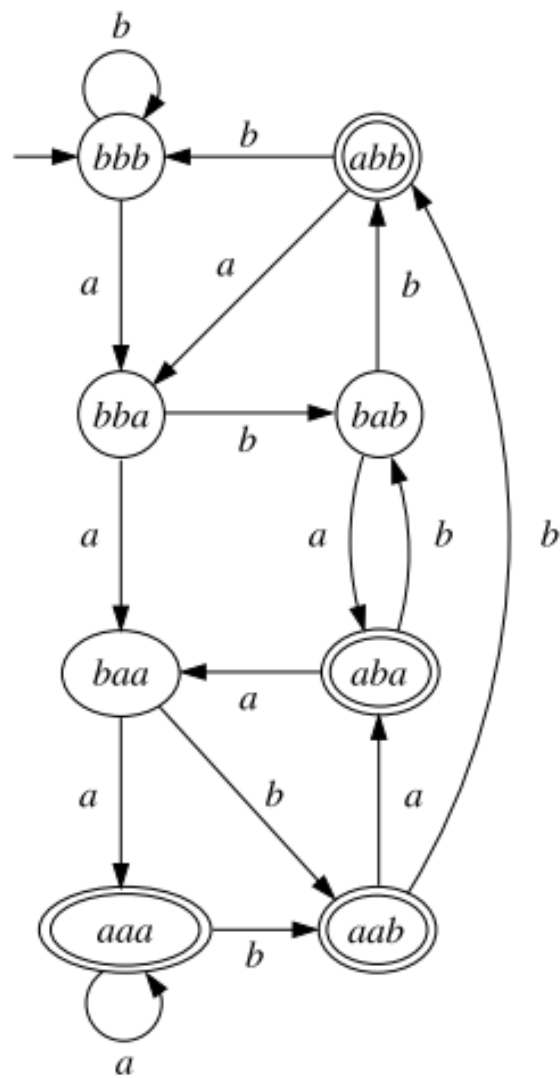
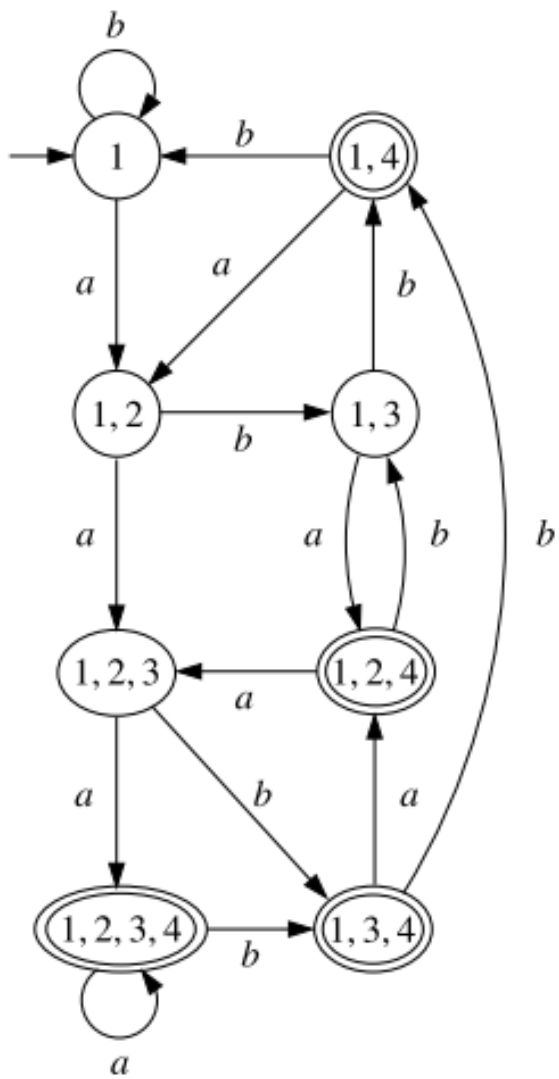
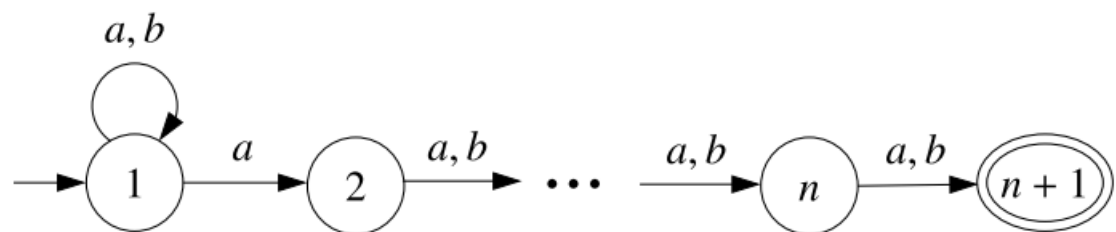

NFA ϵ to NFA

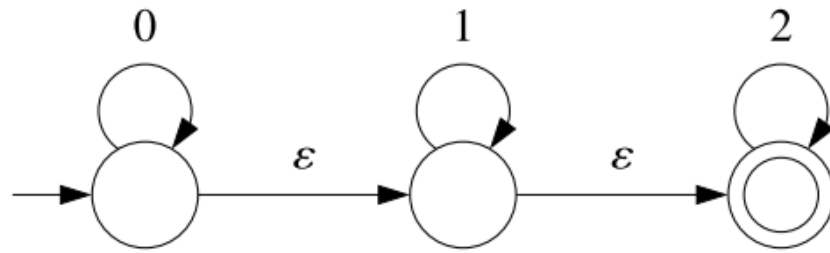

NFA ϵ to NFA

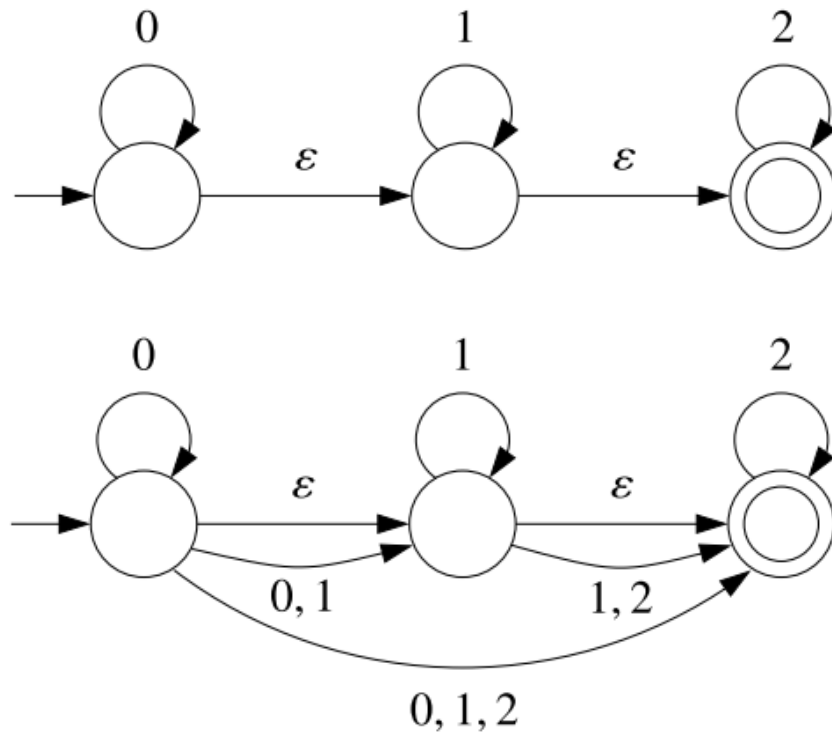

Saturation

NFA ϵ to NFA

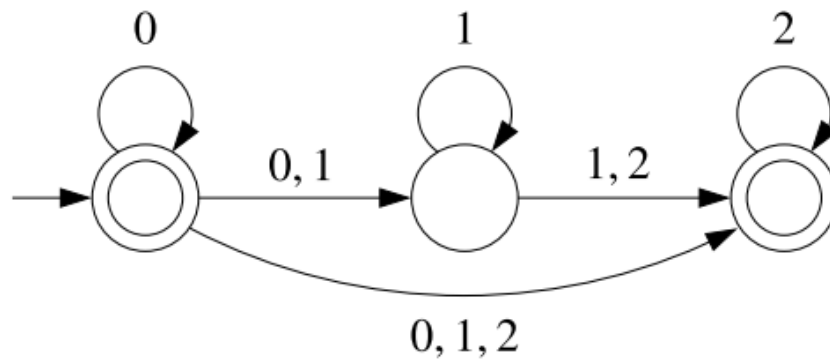
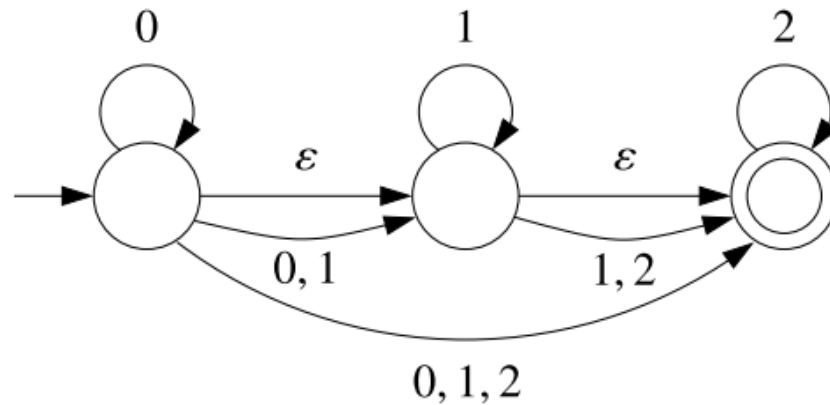
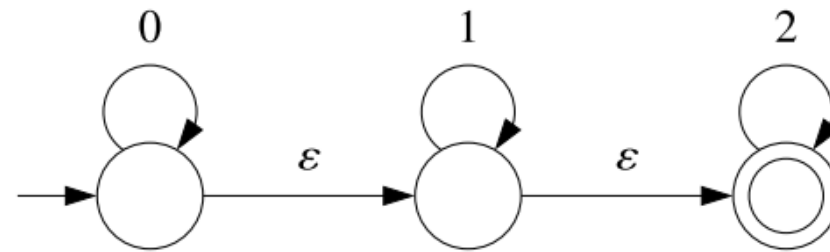

Saturation

Check of the
initial state
+ ϵ -removal

A one-pass algorithm

NFA ϵ toNFA(A)

Input: NFA- ϵ $A = (Q, \Sigma, \delta, Q_0, F)$

Output: NFA $B = (Q', \Sigma, \delta', Q'_0, F')$ with $L(B) = L(A)$

```
1   $Q'_0 \leftarrow Q_0$ 
2   $Q' \leftarrow Q_0; \delta' \leftarrow \emptyset; F' \leftarrow F \cap Q_0$ 
3   $\delta'' \leftarrow \emptyset; W \leftarrow \{(q, \alpha, q') \in \delta \mid q \in Q_0\}$ 
4  while  $W \neq \emptyset$  do
5      pick  $(q_1, \alpha, q_2)$  from  $W$ 
6      if  $\alpha \neq \epsilon$  then
7          add  $q_2$  to  $Q'$ ; add  $(q_1, \alpha, q_2)$  to  $\delta'$ ; if  $q_2 \in F$  then add  $q_2$  to  $F'$ 
8          for all  $q_3 \in \delta(q_2, \epsilon)$  do
9              if  $(q_1, \alpha, q_3) \notin \delta'$  then add  $(q_1, \alpha, q_3)$  to  $W$ 
10         for all  $a \in \Sigma, q_3 \in \delta(q_2, a)$  do
11             if  $(q_2, a, q_3) \notin \delta'$  then add  $(q_2, a, q_3)$  to  $W$ 
12         else  $/ * \alpha = \epsilon * /$ 
13             add  $(q_1, \alpha, q_2)$  to  $\delta''$ ; if  $q_2 \in F$  then add  $q_1$  to  $F'$ 
14             for all  $\beta \in \Sigma \cup \{\epsilon\}, q_3 \in \delta(q_2, \beta)$  do
15                 if  $(q_1, \beta, q_3) \notin \delta' \cup \delta''$  then add  $(q_1, \beta, q_3)$  to  $W$ 
```

Correctness

Proposition. Let A be an NFA ϵ and let $B = \text{NFA}\epsilon\text{toNFA}(A)$. Then B is an NFA and $L(A) = L(B)$.

Proof.

- **Termination.** Every transition that leaves W is never added to W again, and each iteration of the while loop removes one transition from W .
 - B is an NFA. Easy.
 - $L(B) \subseteq L(A)$.
 - Check that every transition added by the algorithm is a shortcut.
 - Check that an initial state q_0 is made into a final state only if A has an ϵ -path from q_0 to a final state.
- Invariant:** At line 13, $q_1 \in Q_0$. Proof by induction, observing that the algorithm only adds ϵ -transitions to W at line 15.

Correctness

- $L(A) \subseteq L(B)$

If $\epsilon \in L(A)$ then $\epsilon \in L(B)$

$$q_0 \xrightarrow{\epsilon} q_1 \xrightarrow{\epsilon} q_2 \xrightarrow{\epsilon} q_3 \xrightarrow{\epsilon} q_4$$

If $w \neq \epsilon$ and $w \in L(A)$ then $w \in L(B)$

$$q_0 \xrightarrow{\epsilon} q_1 \xrightarrow{\epsilon} q_2 \xrightarrow{a_1} q_3 \xrightarrow{\epsilon} q_4 \xrightarrow{\epsilon} q_5 \xrightarrow{a_2} q_5 \xrightarrow{\epsilon} q_6$$

Regular expressions to NFA ϵ

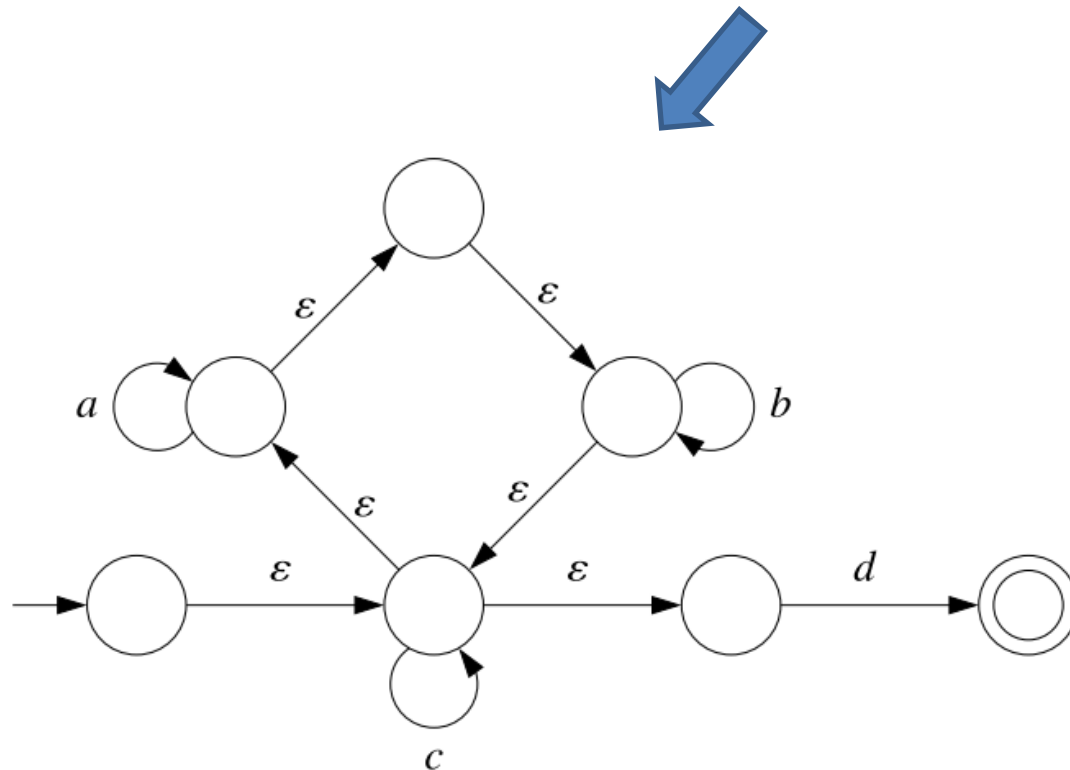
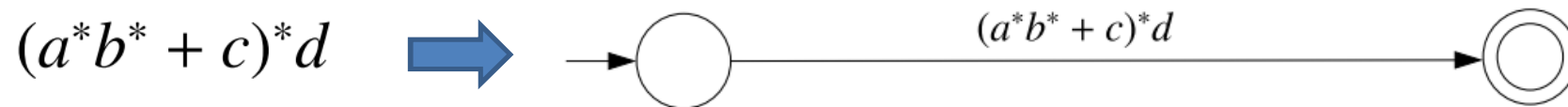

Regular expressions to NFA ϵ

- **Preprocessing:** Convert the regular expression into another one which is either equal to \emptyset , or does not contain any occurrence of \emptyset .
- Use the following rewrite rules:

$$\begin{array}{lcl} \emptyset \cdot r & \rightsquigarrow & \emptyset \\ r + \emptyset & \rightsquigarrow & r \\ \emptyset^* & \rightsquigarrow & \epsilon \end{array} \qquad \begin{array}{lcl} r \cdot \emptyset & \rightsquigarrow & \emptyset \\ \emptyset + r & \rightsquigarrow & r \end{array}$$

Regular expressions to NFA ϵ

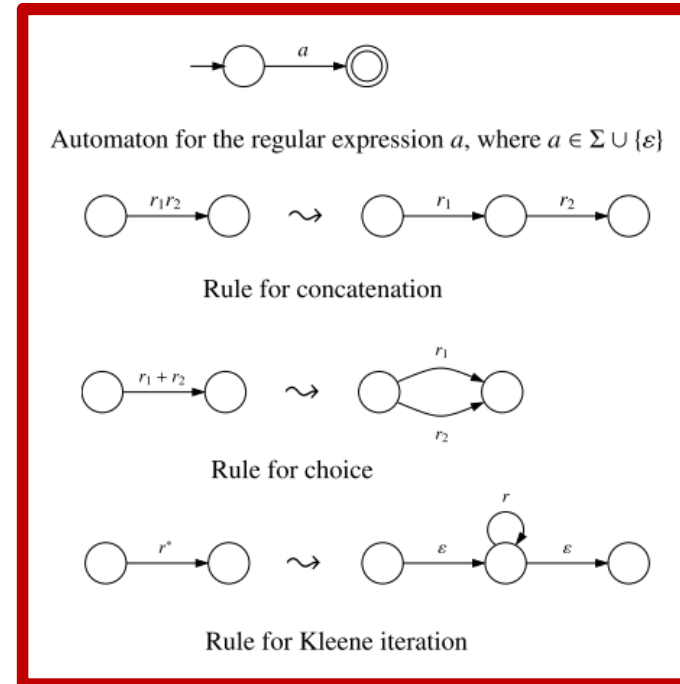
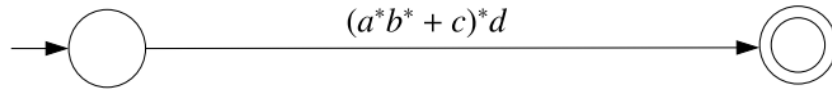

Regular expressions to NFA ϵ

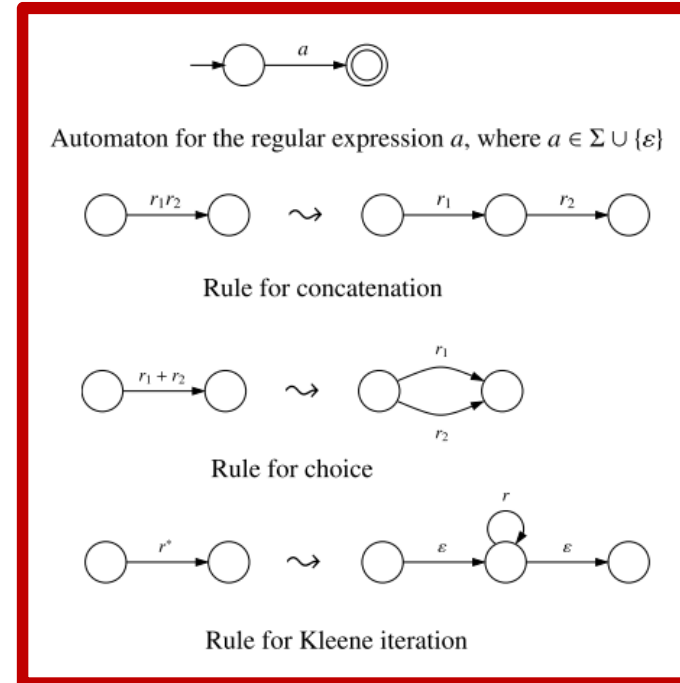
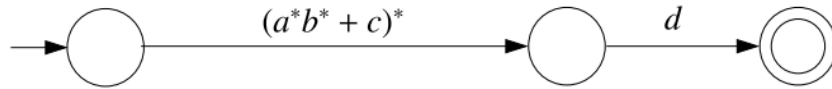
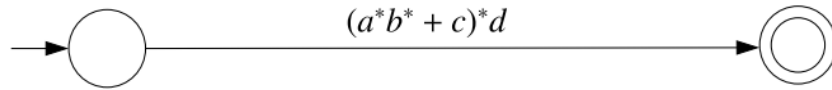

Regular expressions to NFA ϵ

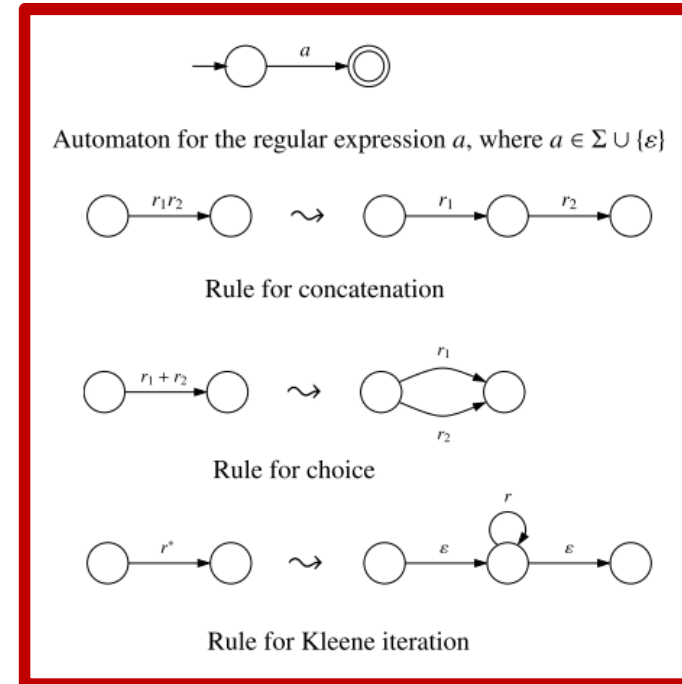
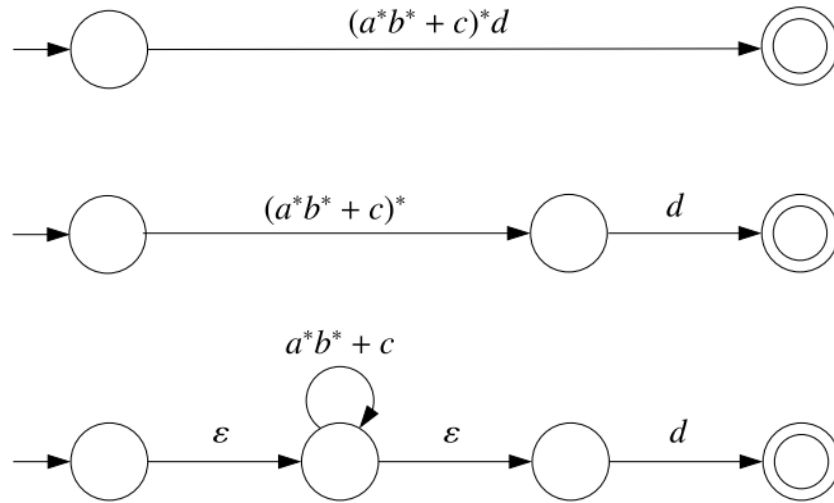

Regular expressions to NFA ϵ

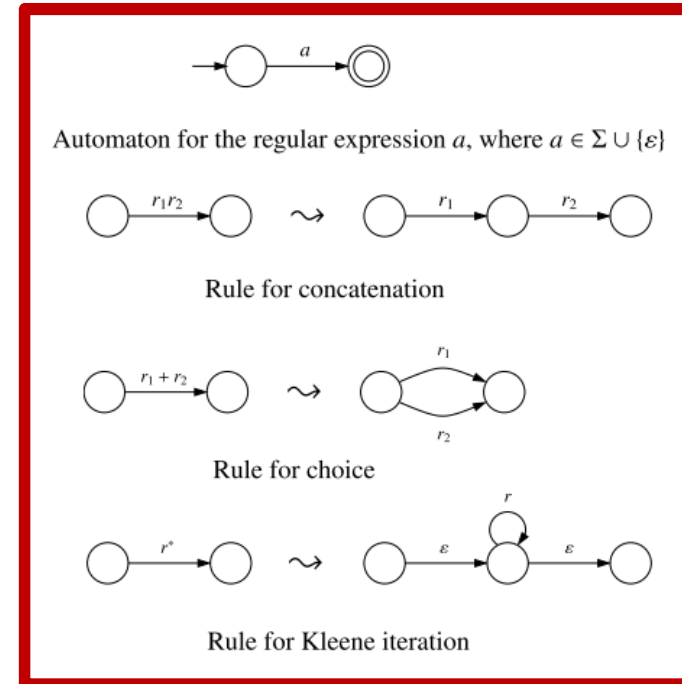
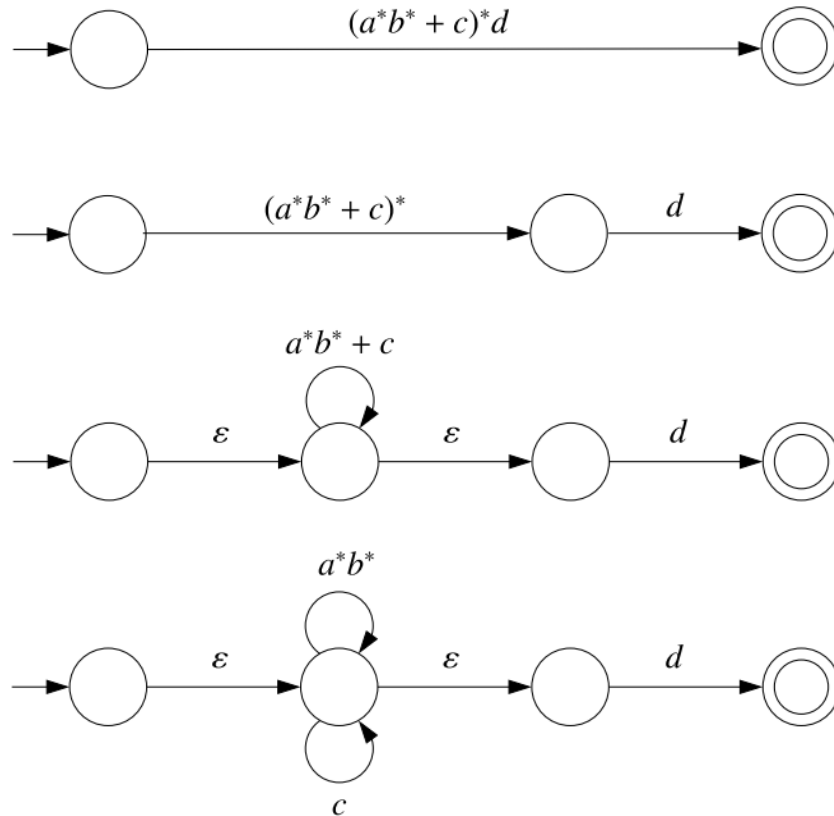

Regular expressions to NFA ϵ

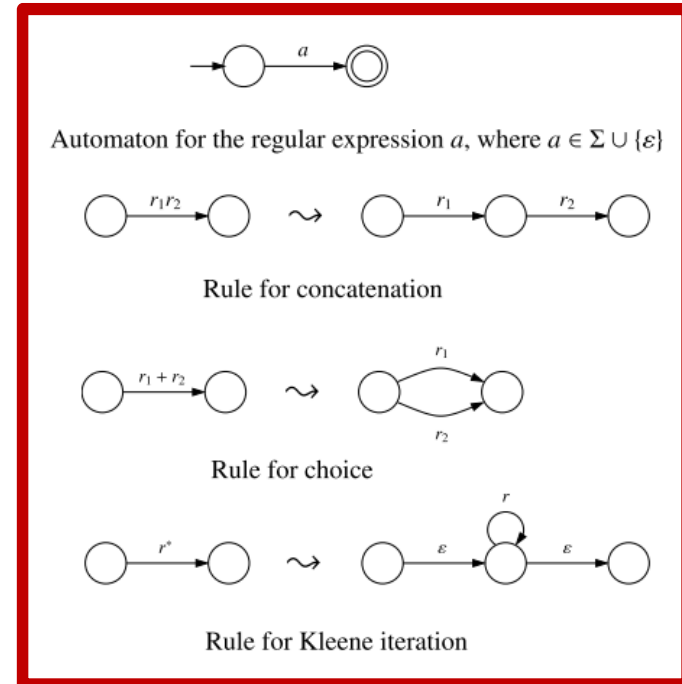
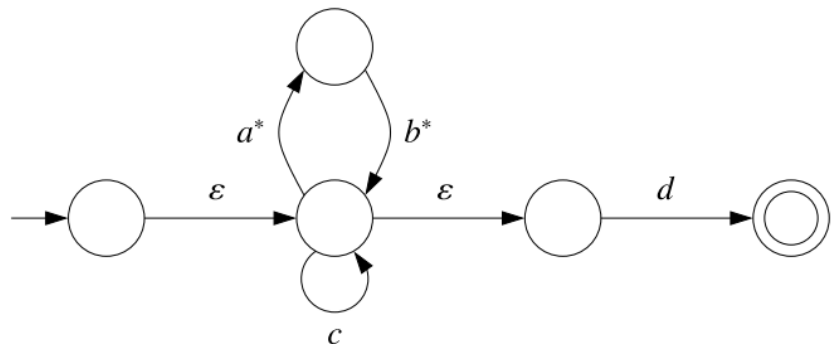
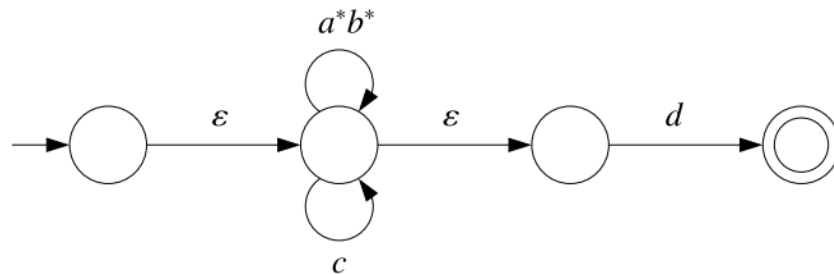
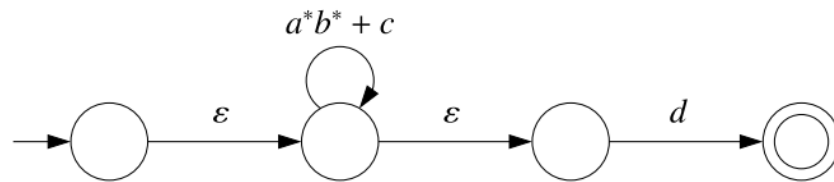
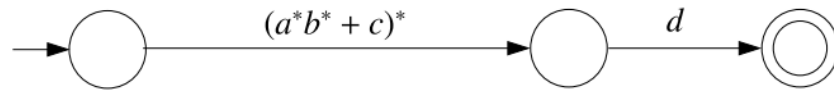
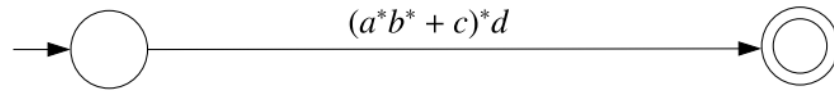

Regular expressions to NFA ϵ

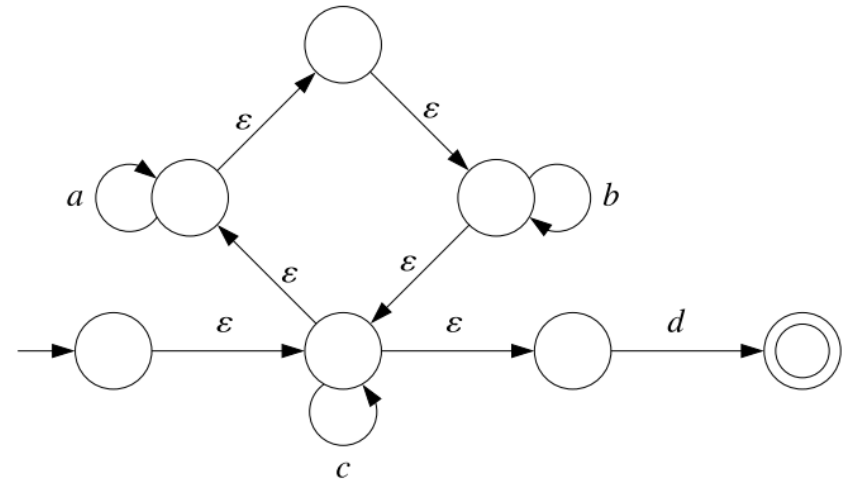
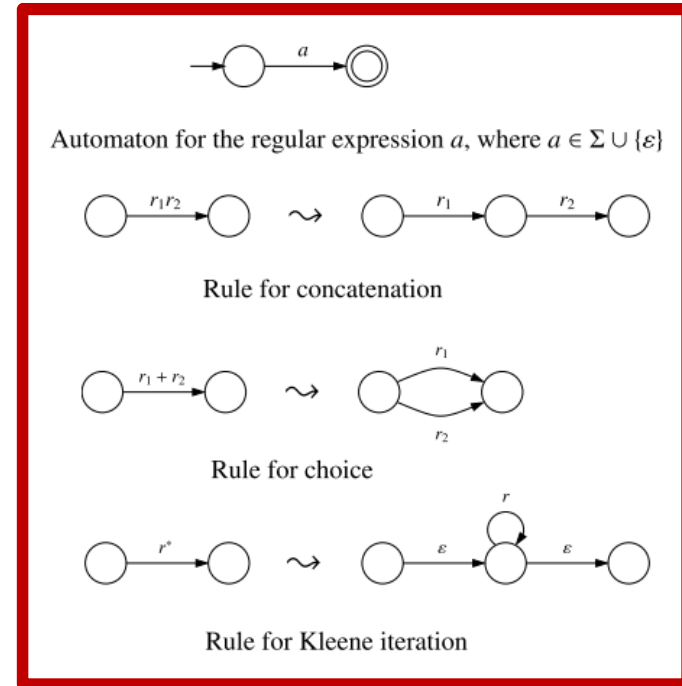
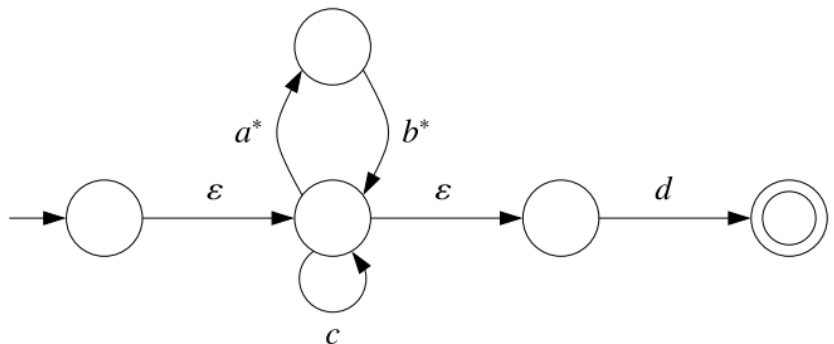
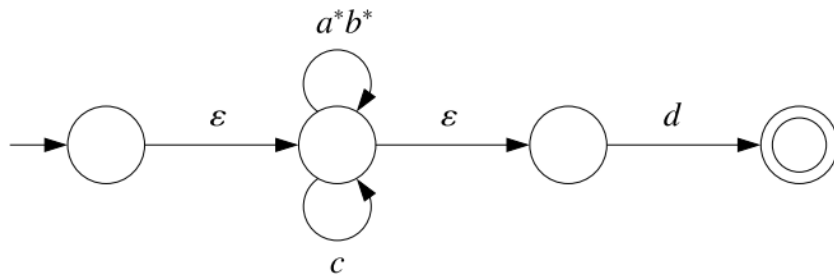
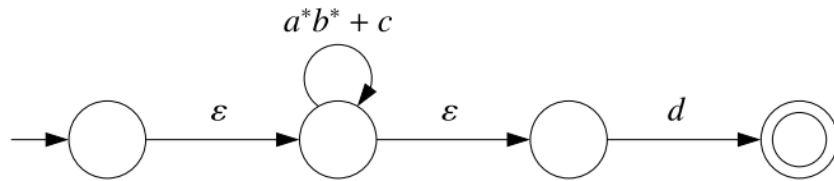
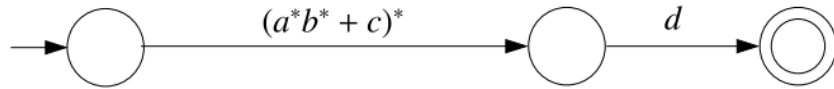
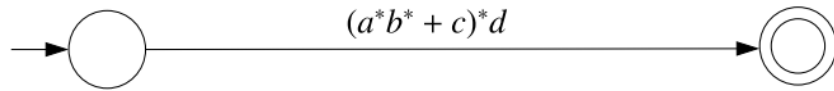

NFA ϵ to regular expressions

- Preprocessing: convert into an NFA- ϵ with
 - one initial state without input transitions, and
 - one final state without output transitions.

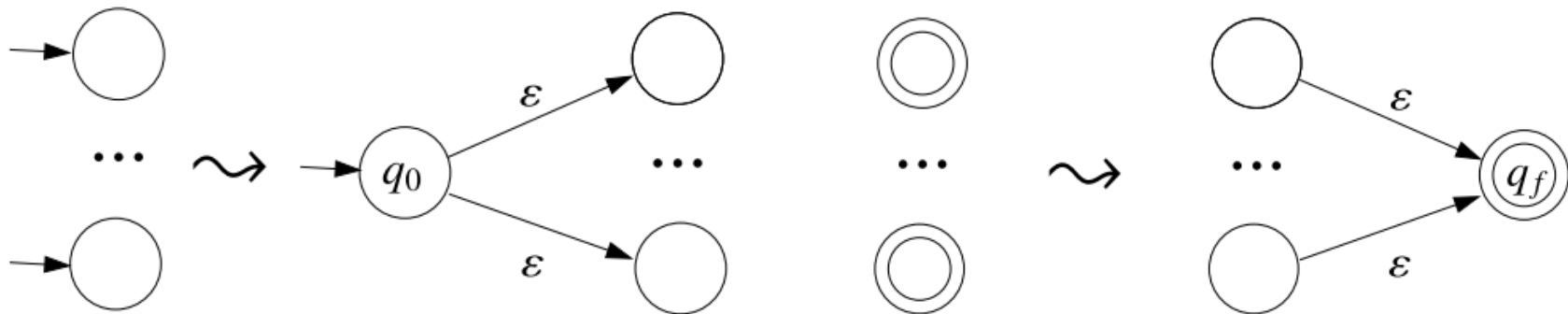

NFA ϵ to regular expressions

- Processing: apply the following two rules, given priority to the first one.

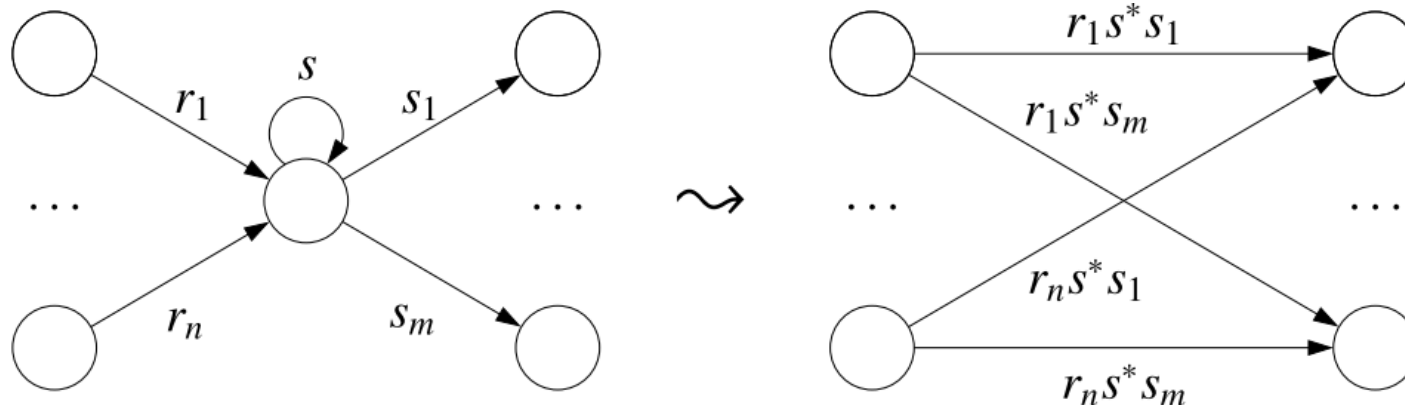
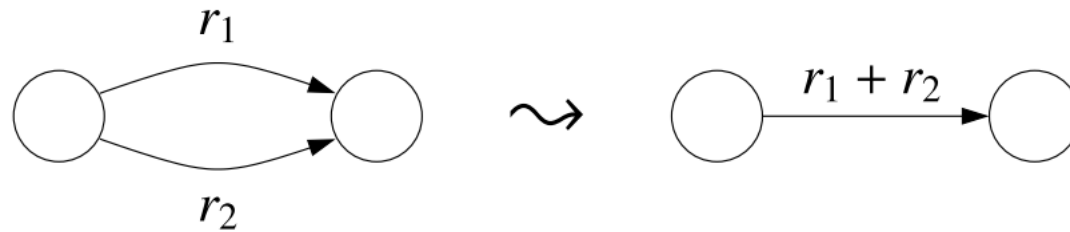

NFA ϵ to regular expressions

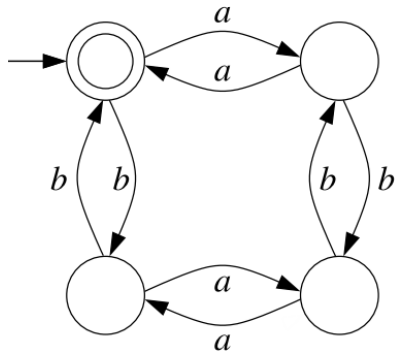

NFA ϵ to regular expressions

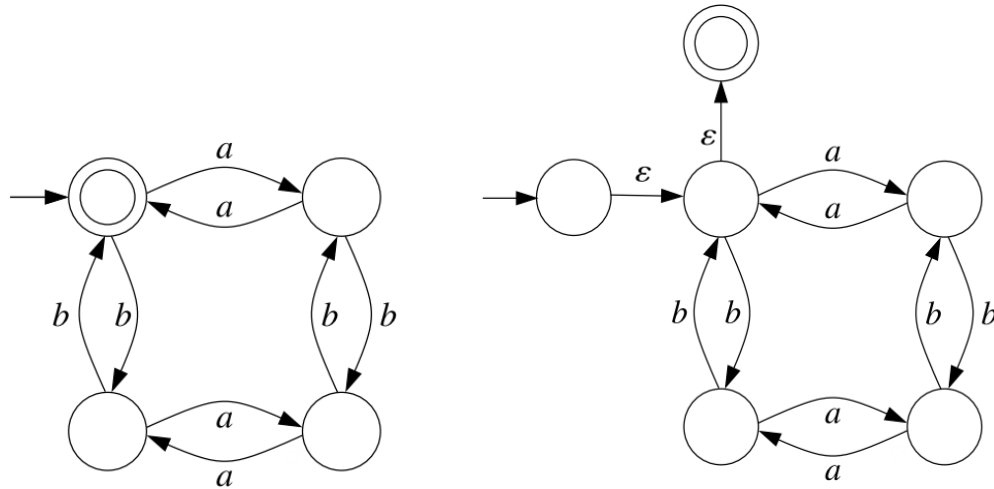

NFA ϵ to regular expressions

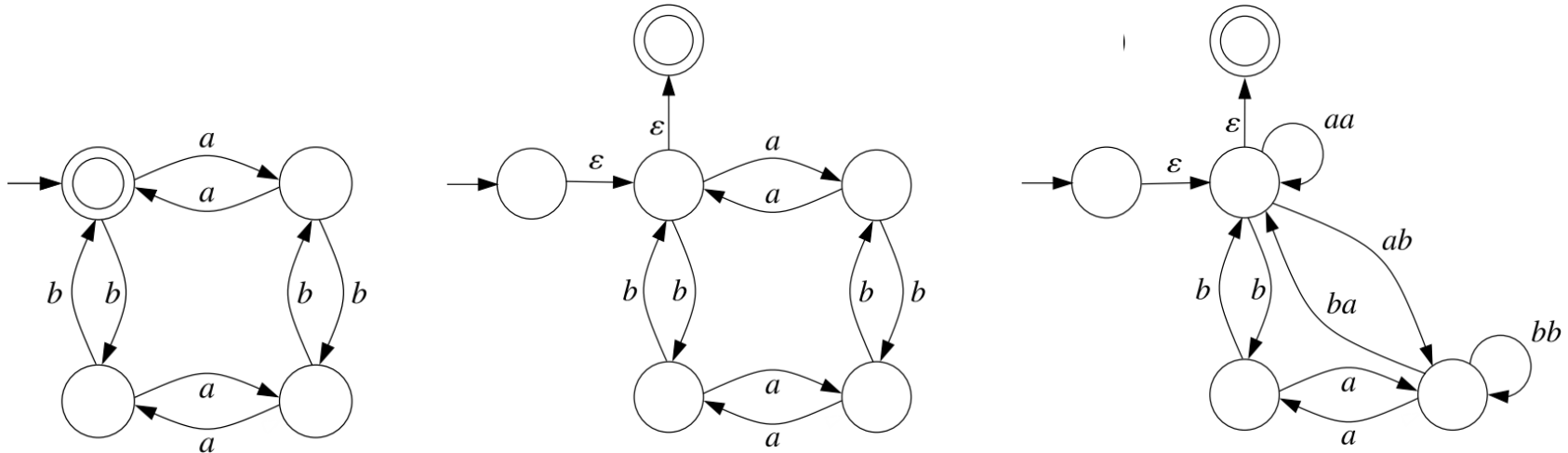

NFA ϵ to regular expressions

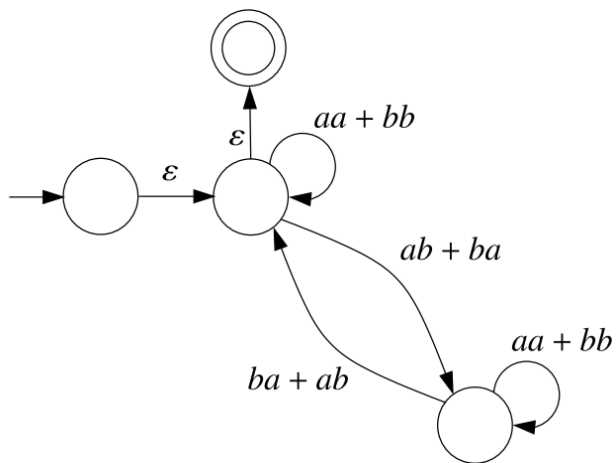
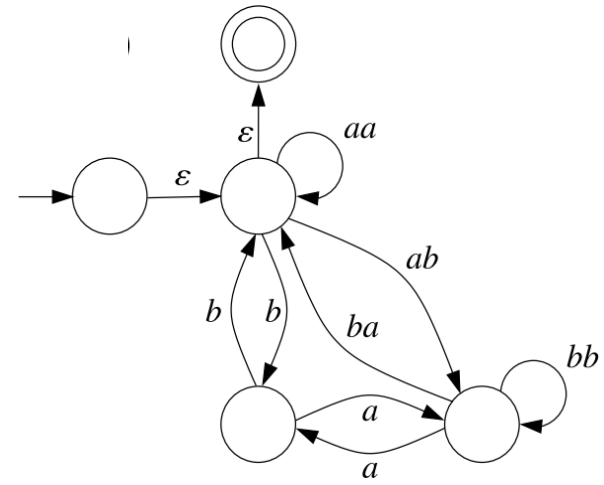
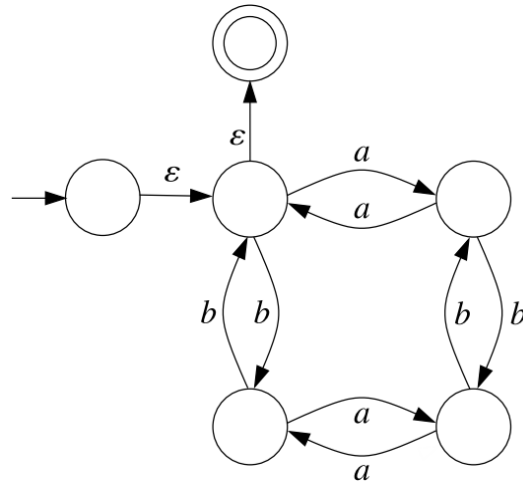
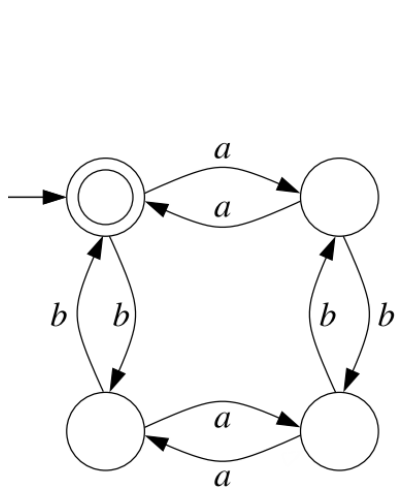

NFA ϵ to regular expressions

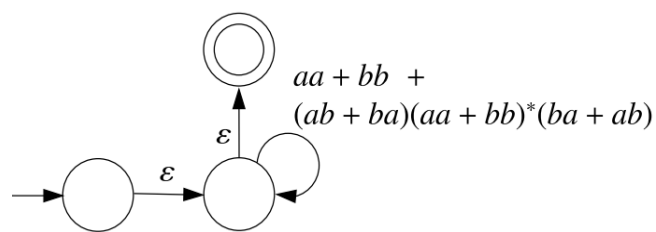
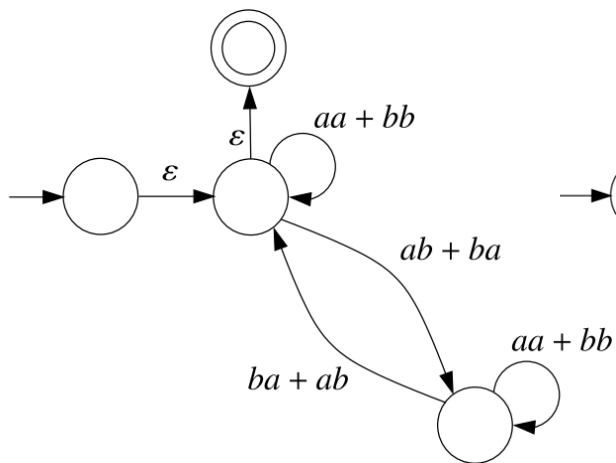
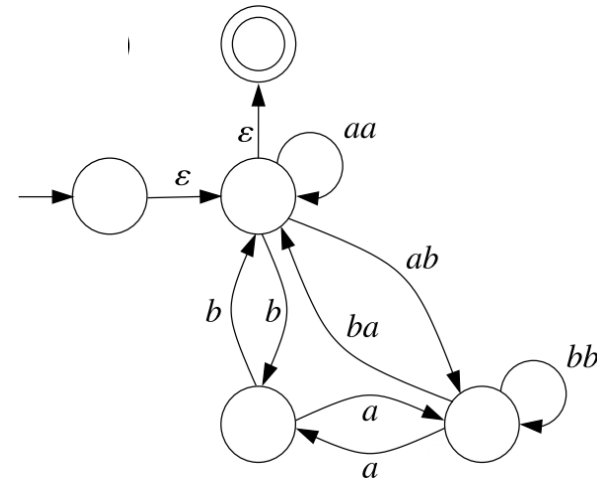
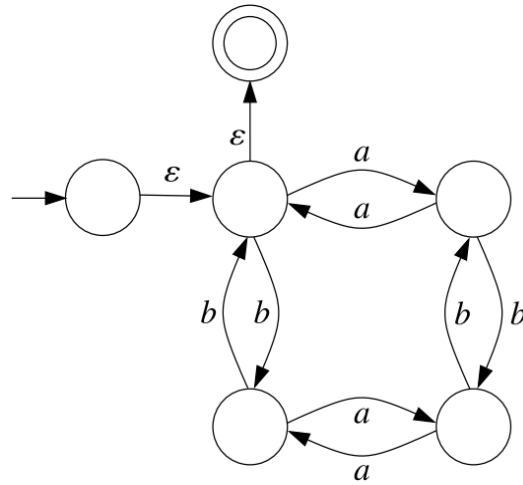
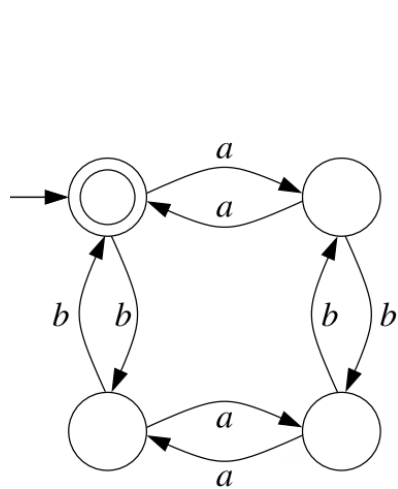

NFA ϵ to regular expressions

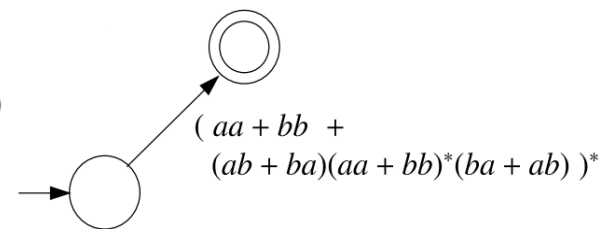
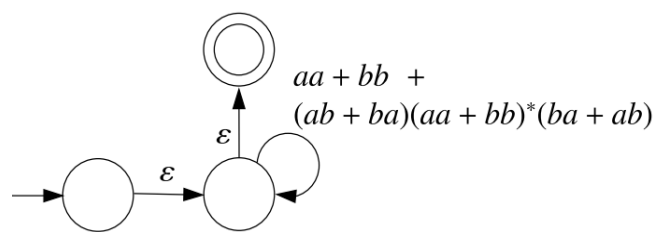
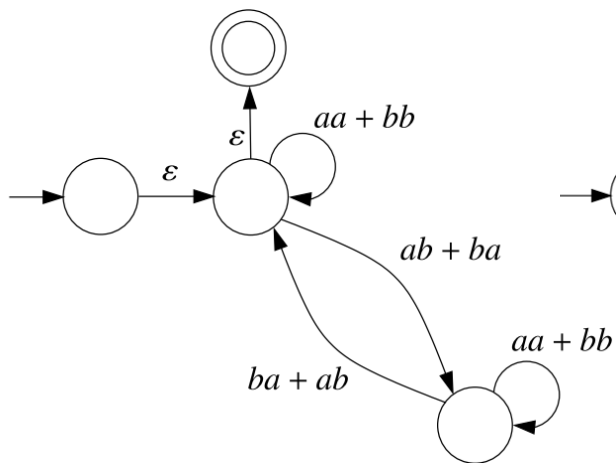
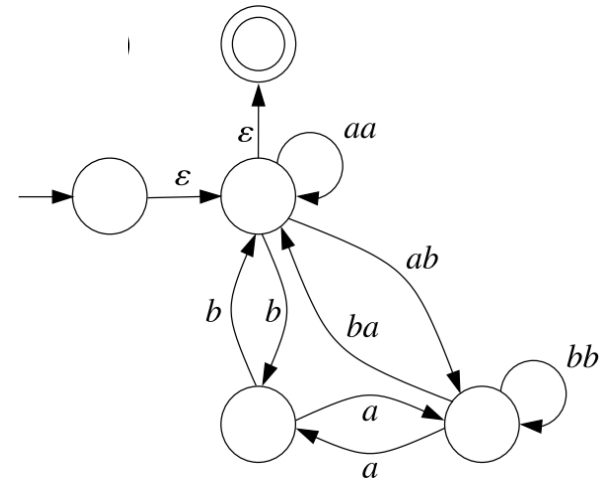
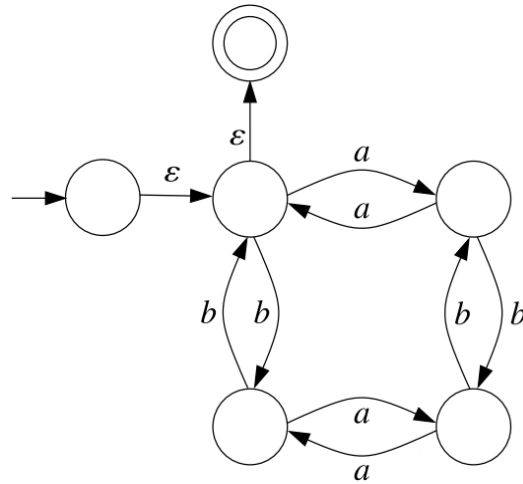
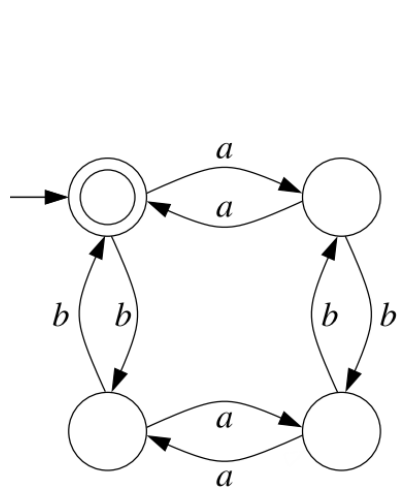

A Tour of Conversions

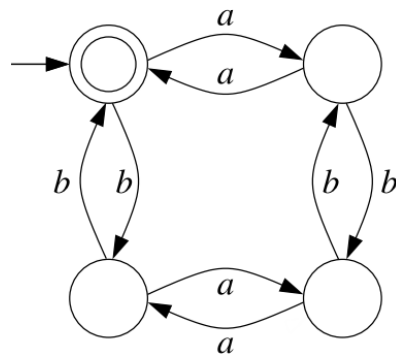

A Tour of Conversions

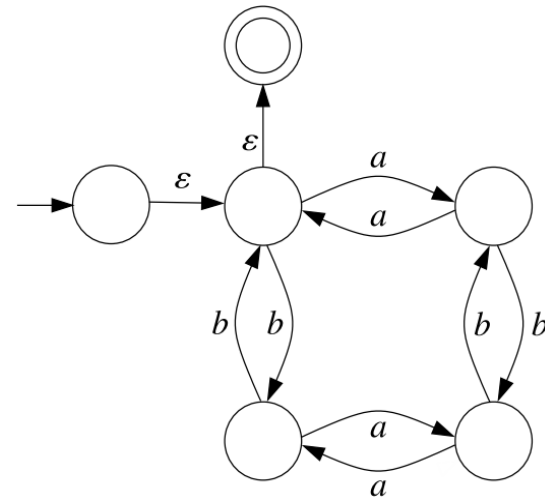

A Tour of Conversions

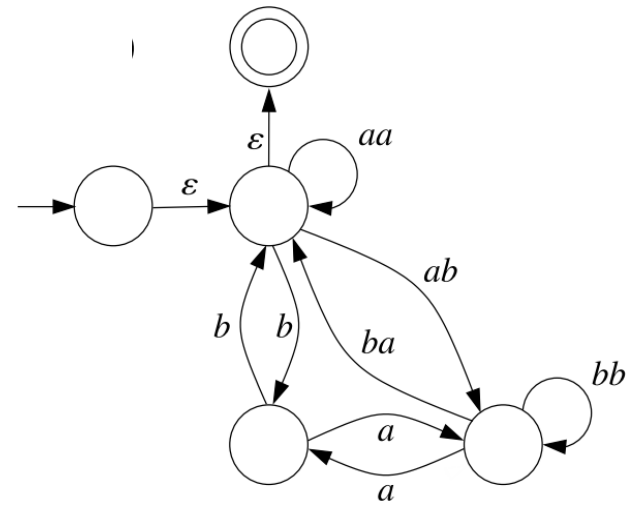

A Tour of Conversions

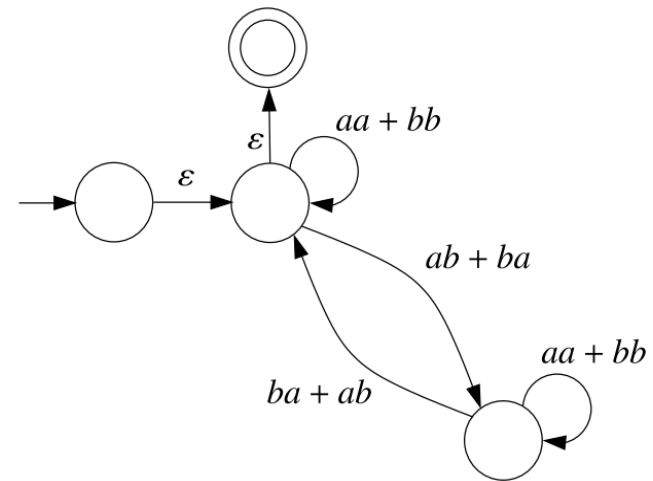

A Tour of Conversions

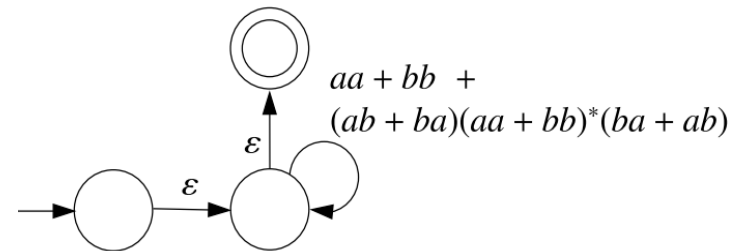

A Tour of Conversions

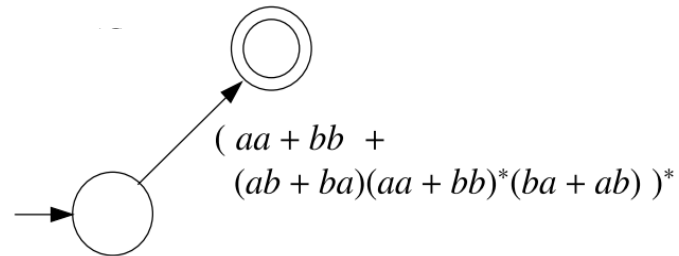

A Tour of Conversions

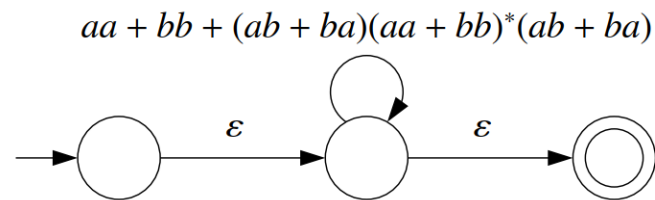

A Tour of Conversions

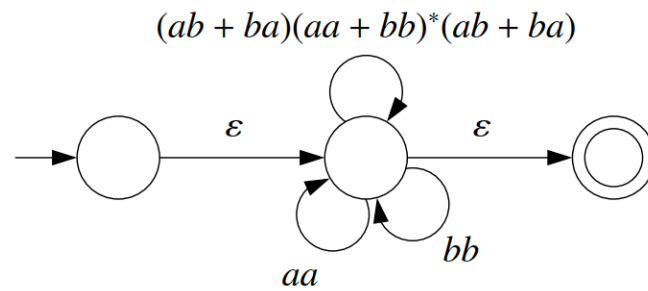

A Tour of Conversions

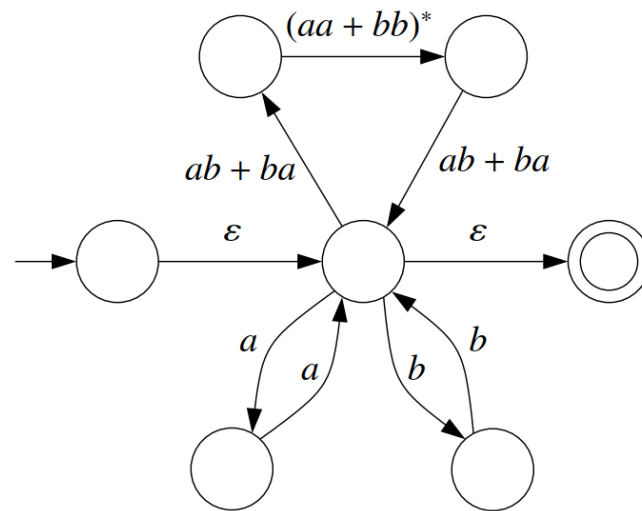

A Tour of Conversions

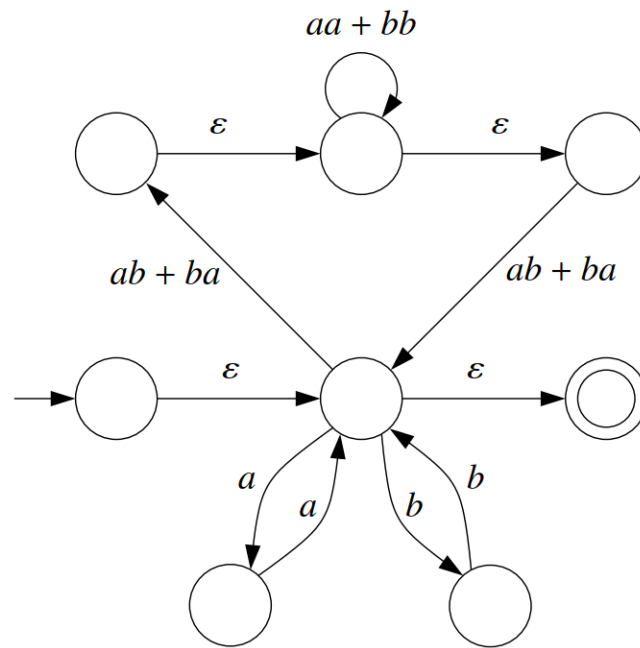

A Tour of Conversions

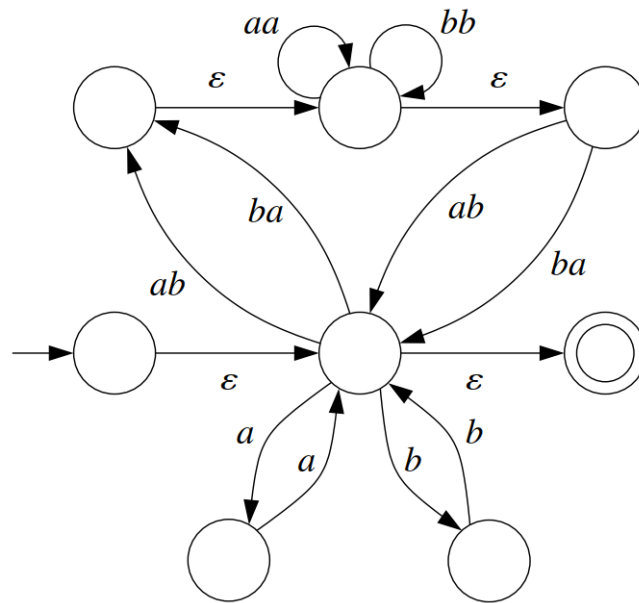

A Tour of Conversions

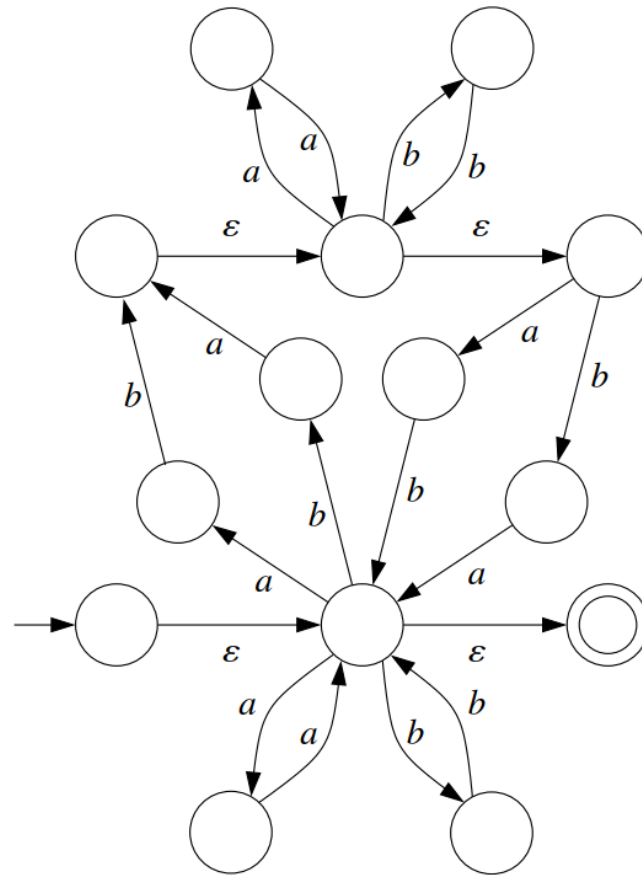

A Tour of Conversions

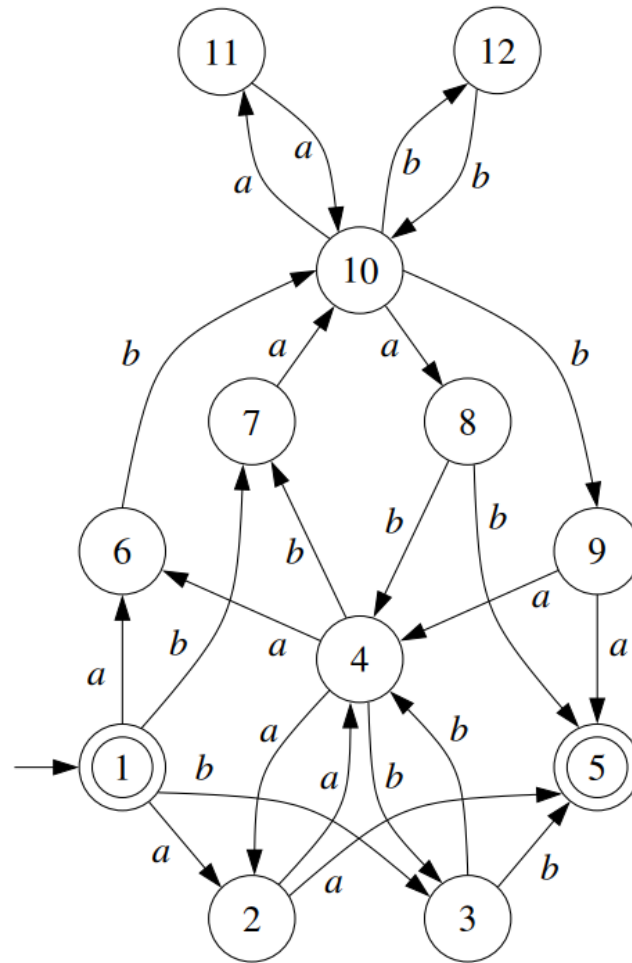

A Tour of Conversions

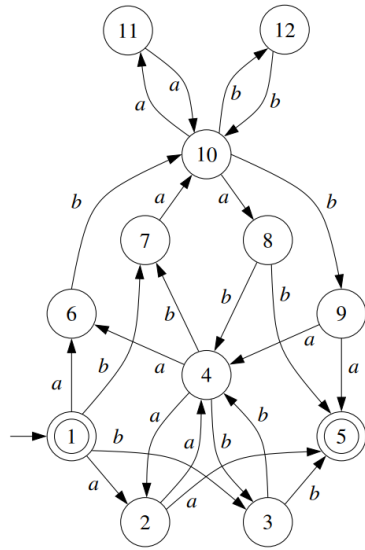

A Tour of Conversions

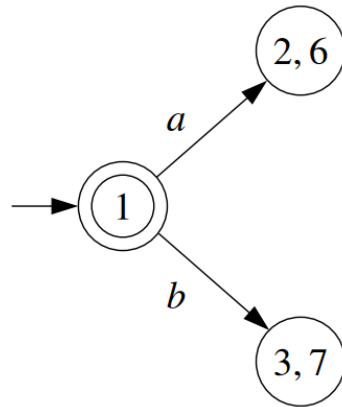
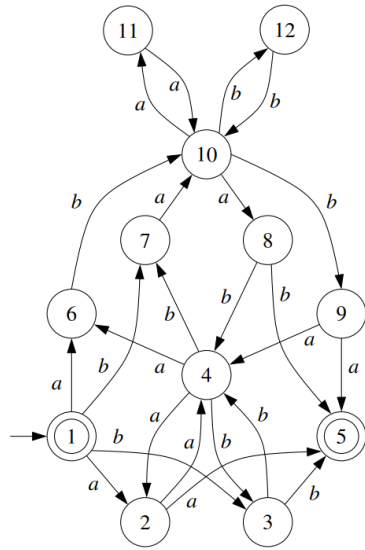

A Tour of Conversions

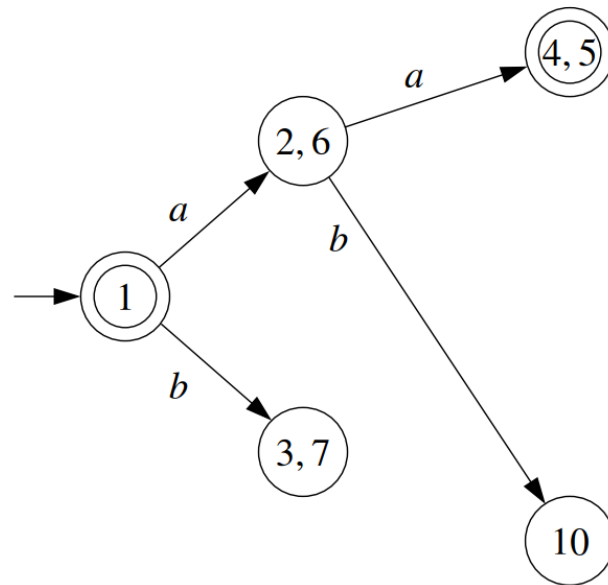
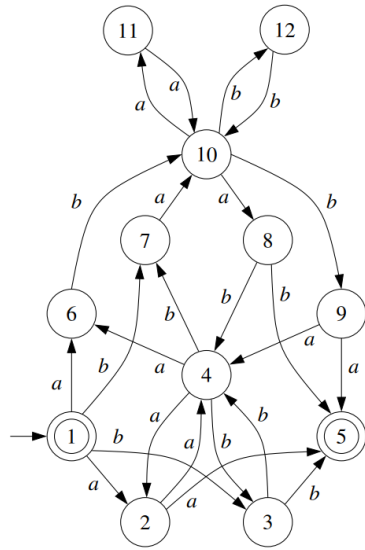

A Tour of Conversions

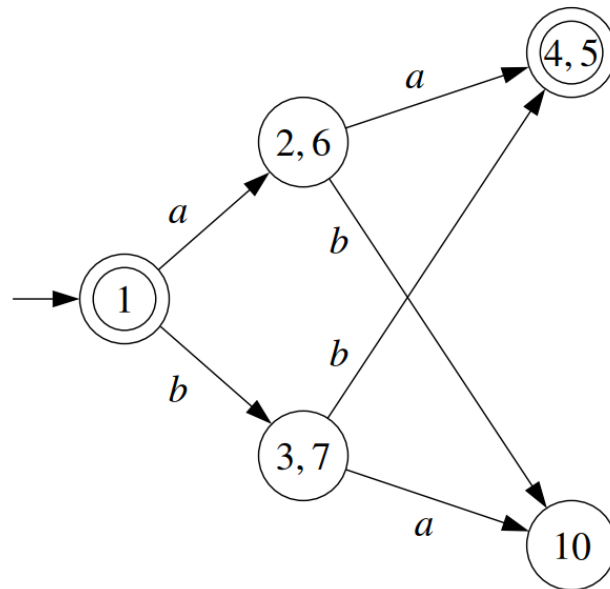
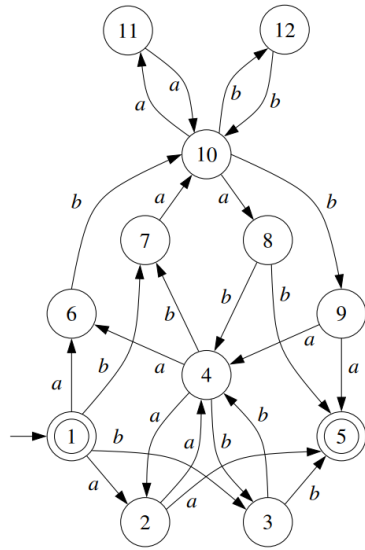

A Tour of Conversions

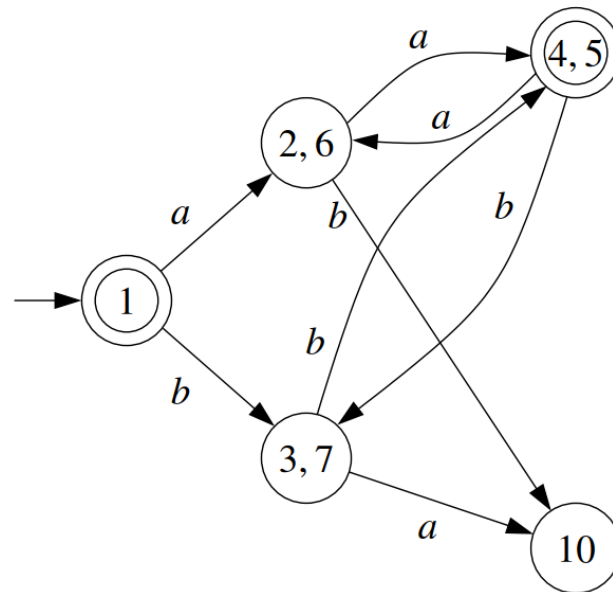
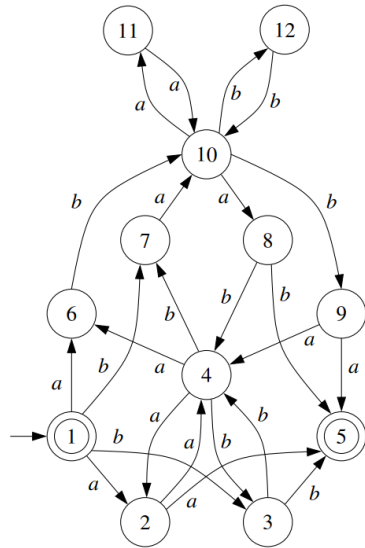

A Tour of Conversions

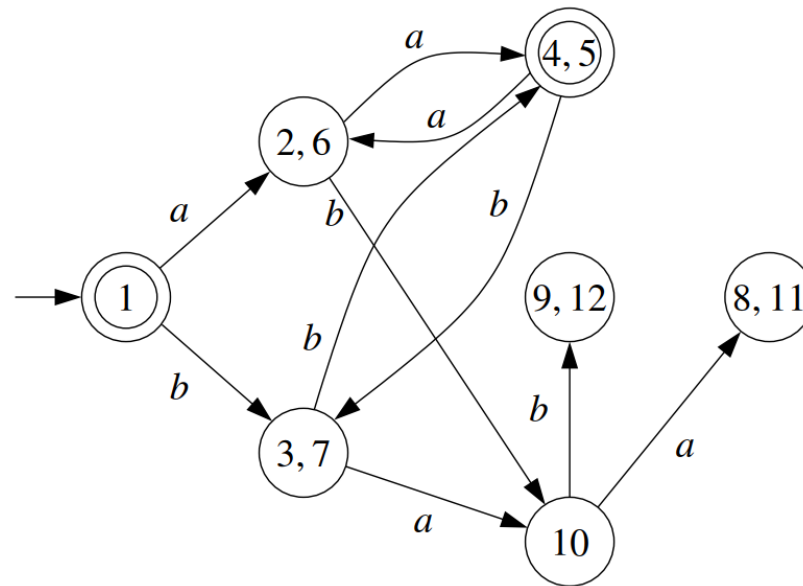
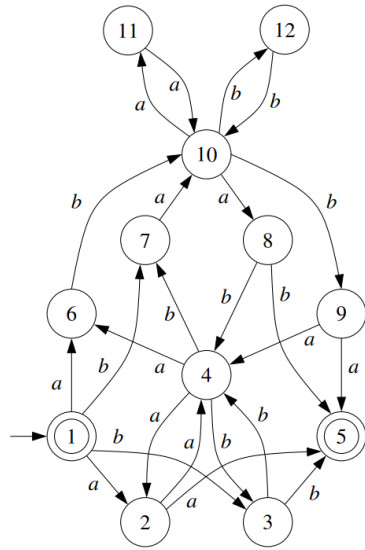

A Tour of Conversions

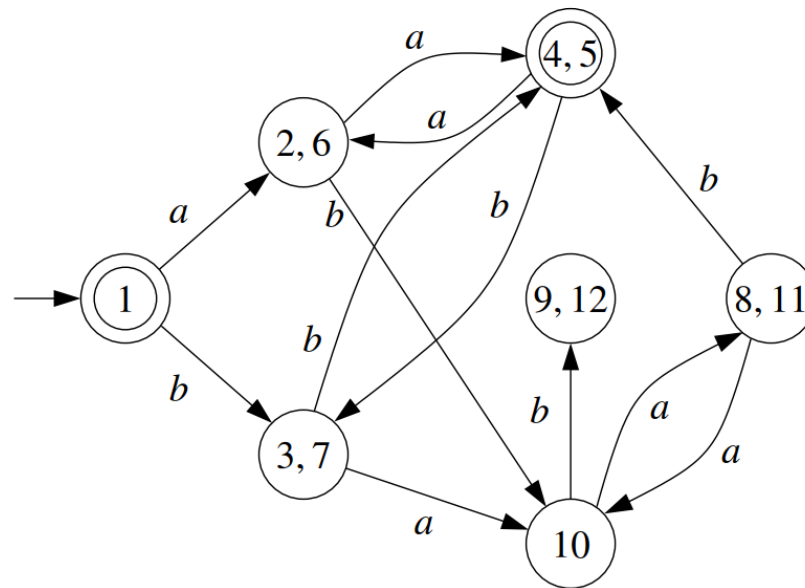
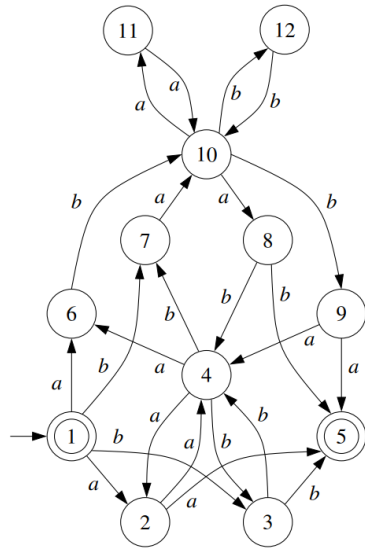

A Tour of Conversions

